

STEREO GRAPHIC EQUALIZER

GE-850

SERVICE MANUAL

KENWOOD

© 1991-7 PRINTED IN JAPAN
B51-4349-00(O) 1941

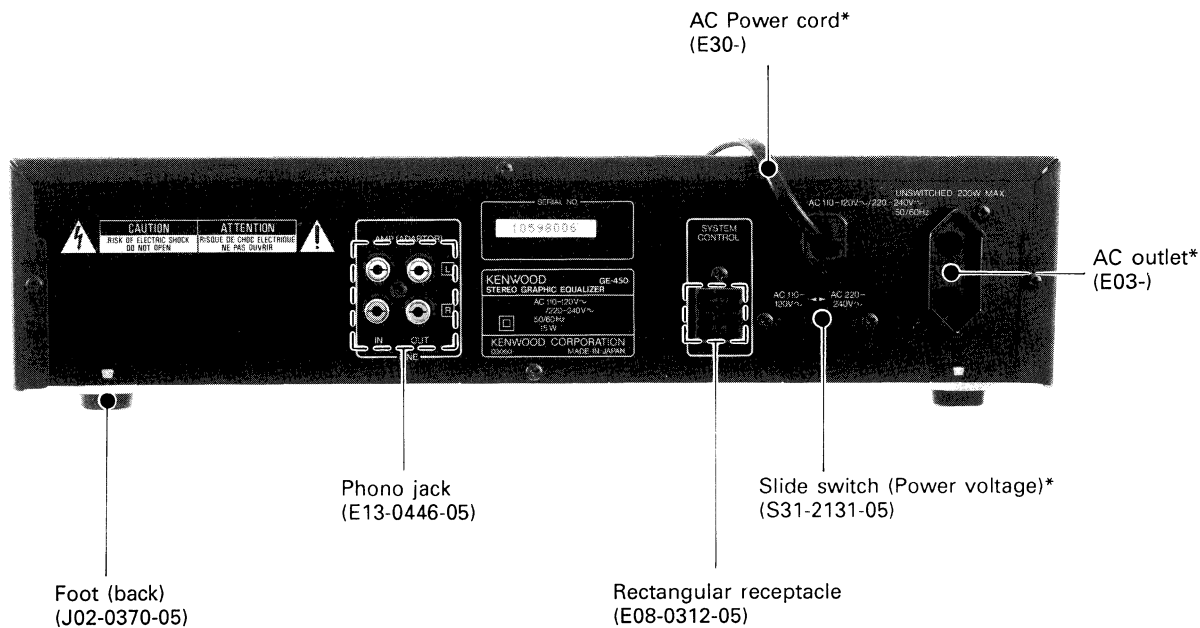
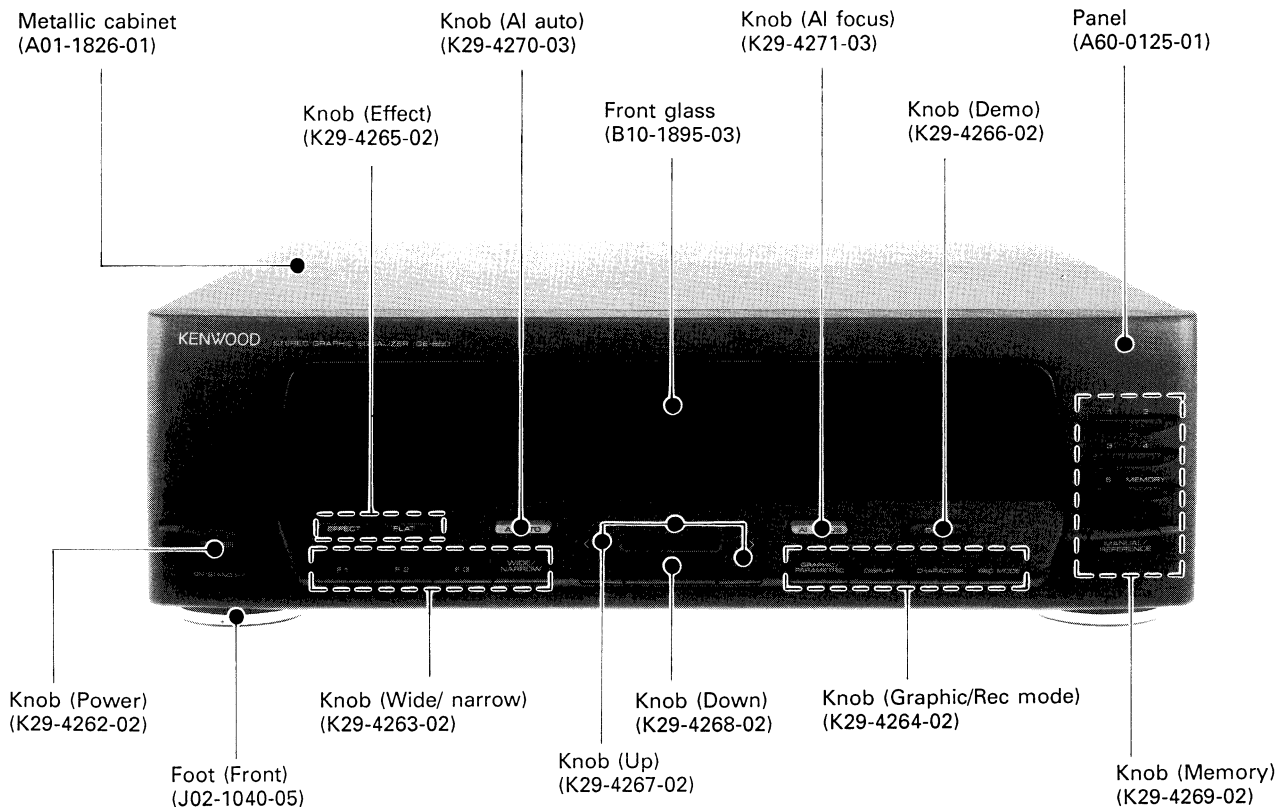

* Refer to parts list on page 24.

GE-850

CONTENTS / ACCESSORIES

Contents

ACCESSORIES	2	5. Transfer Method	9
CONTROLS/CAUTION	3	6. Display Microprocessor : M50747-F92SP	
CIRCUIT DESCRIPTION		(IC5 : X14-3240-21)	10
1. Microprocessor Block		PC BOARD (COMPONENT SIDE VIEW)	12
Diagram and key matrix	4	SCHEMATIC DIAGRAM	15
2. Main Microprocessor		EXPLODED VIEW	23
: M50945-104SP (IC6 : X14-3240-21)	6	PARTS LIST	24
3. Data of MEMORY EQ CURVE	8	SPECIFICATIONS	28
4. Test Mode	8		

Accessories

AC plug adaptor1

(Except for some areas)
For the unit with a European AC
plug in areas other than Europe.

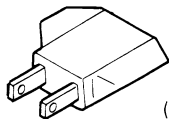

(E03-0115-05)

Audio cord 2

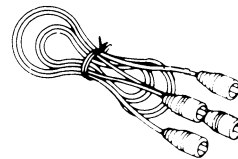

(E30-0505-05)

System control cord 1

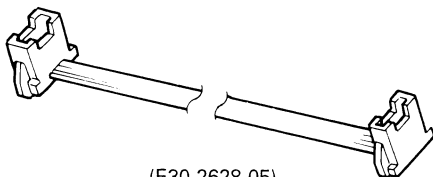

(E30-2628-05)

CONTROLS / CAUTION

Controls

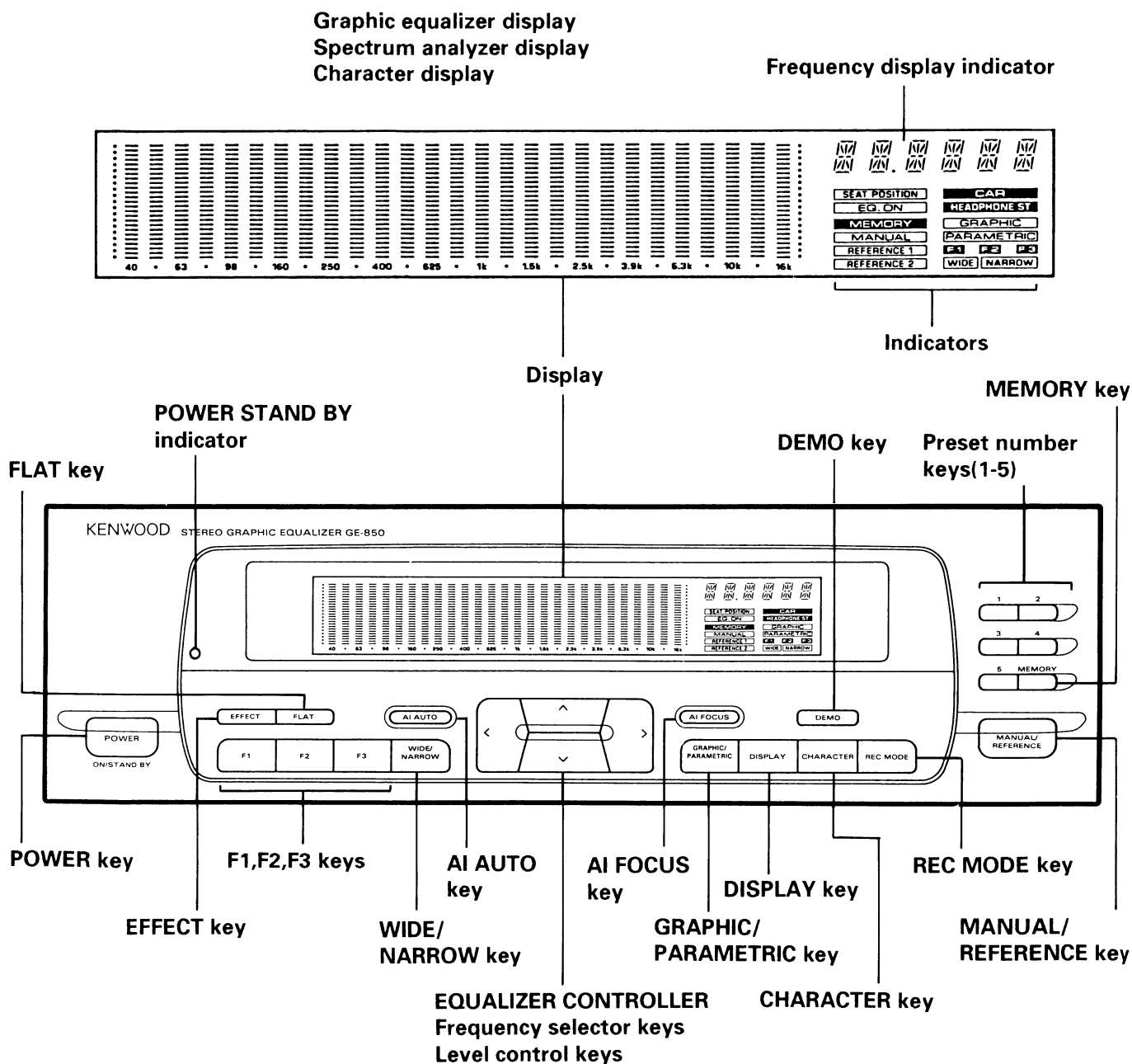

Caution

STAND BY mode of POWER switch

When the power cord of this system is plugged into an AC outlet, the STAND BY indicator lights up regardless of the ON/OFF setting of the POWER switch. This indicates that a small amount of current is being supplied to the unit to back up the memory contents. This mode is referred to as the Stand By mode.

Lights up

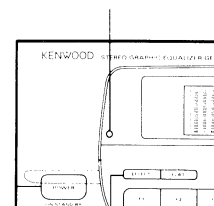

GE-850

CIRCUIT DESCRIPTION

1. Microprocessor Block Diagram and Key Matrix

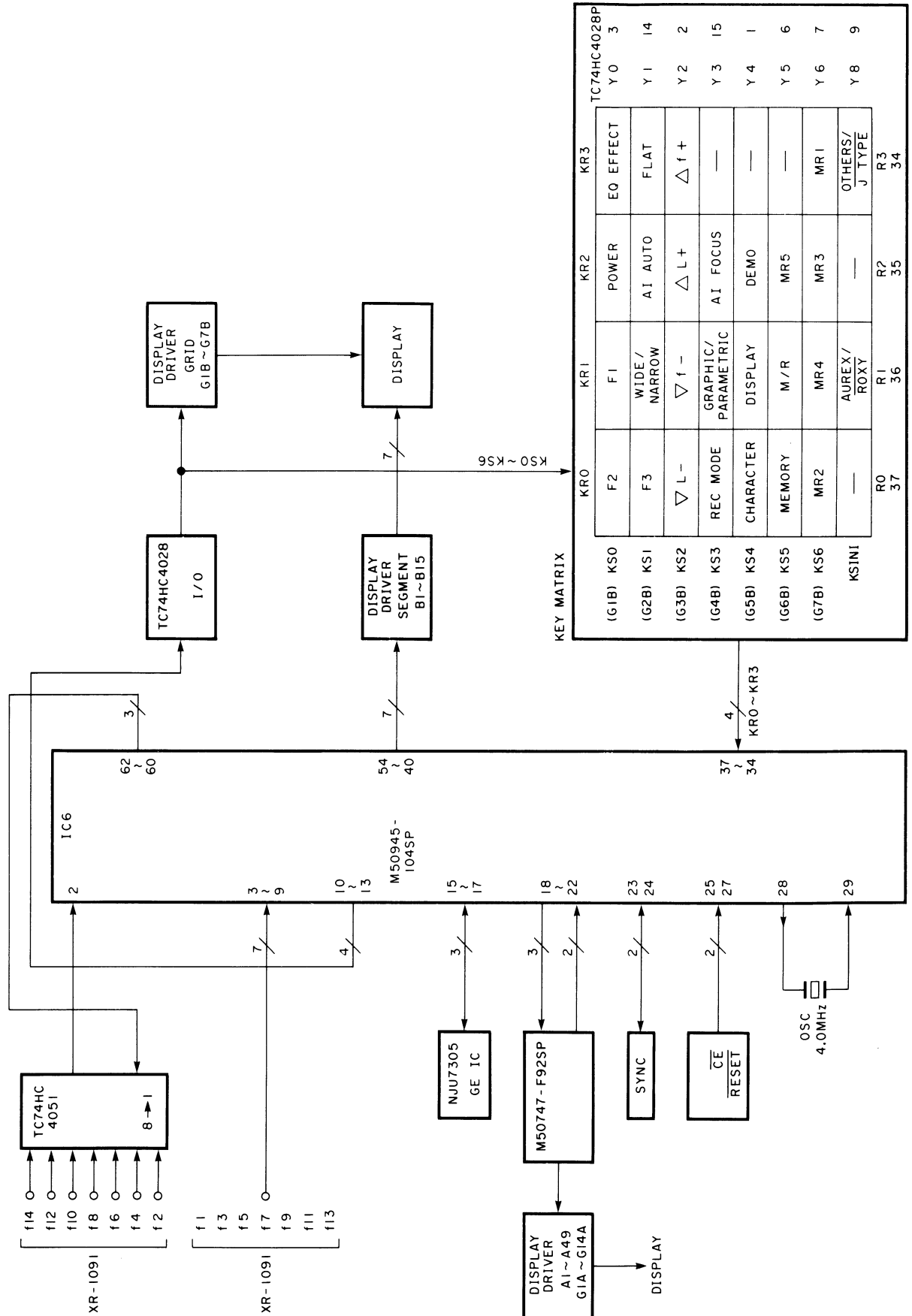

CIRCUIT DESCRIPTION

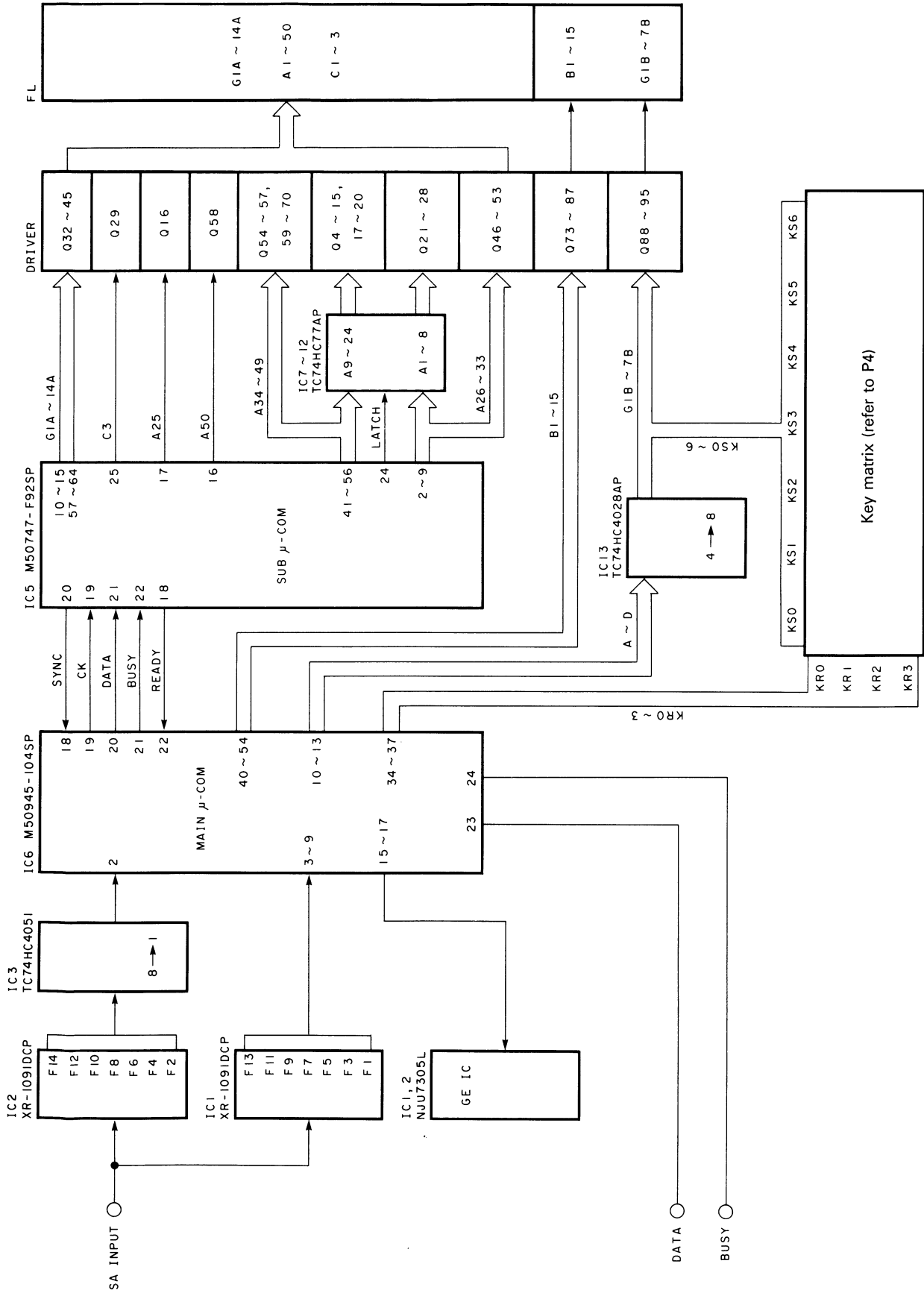

GE-850

CIRCUIT DESCRIPTION

2. Main Microprocessor : M50945-104SP (IC6 : X14-3240-21)

2-1. Terminal connection diagram

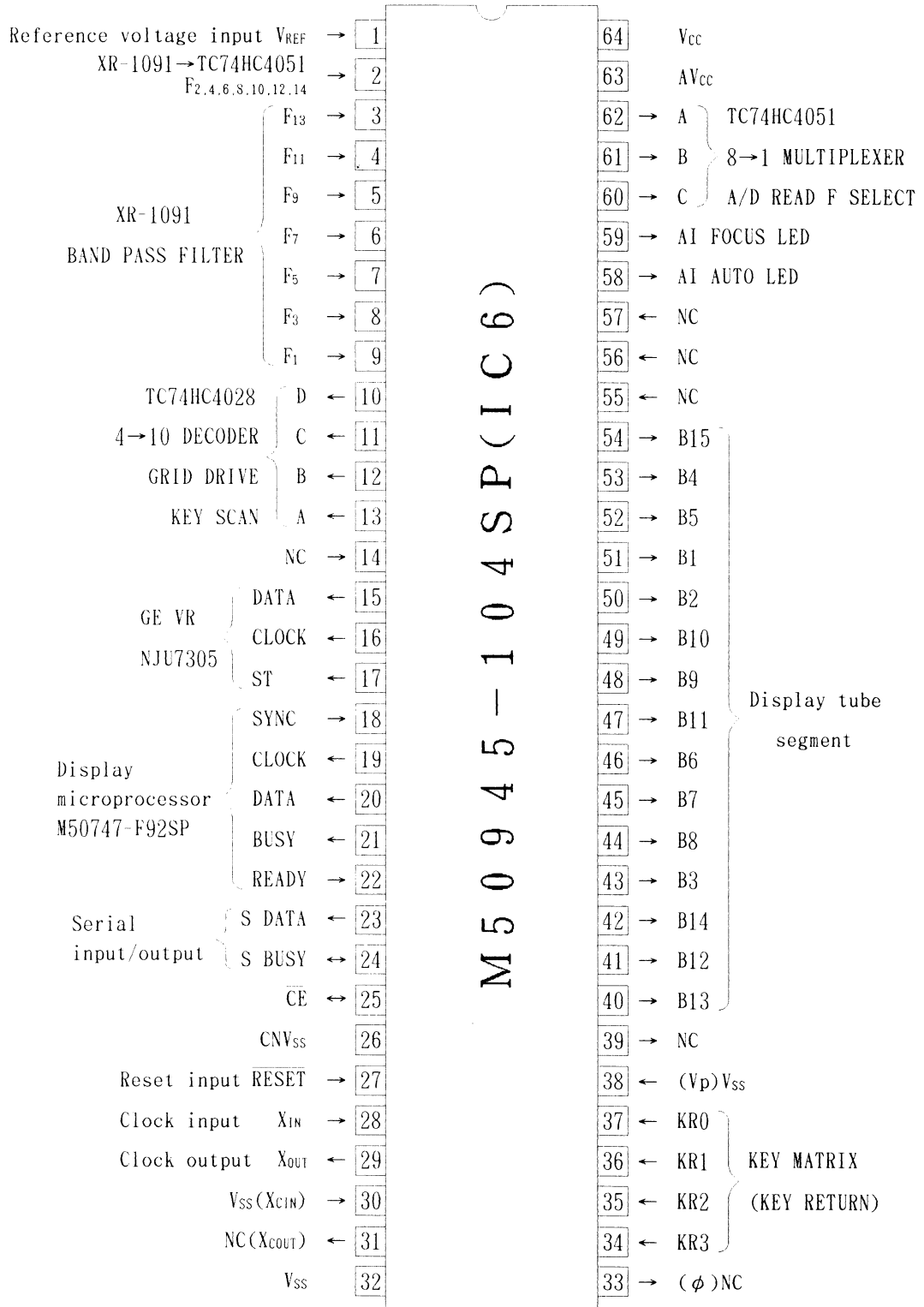

CIRCUIT DESCRIPTION

2-2. Description of terminals

Pin No.	Pin Name	I/O	Name	Description
1	VREF	-	VREF	Reference voltage input for A/D converter.
2	IN7	I	F8~F14	Analog signal input for 1kHz~16kHz and AMP VR position detection. (For inputting signal coming in by way of Multiplexer TC74HC4051.)
3	IN6	I	F13	10kHz analog signal input. (For inputting signals coming in directly from filter circuit.)
4	IN5	I	F11	3.9kHz analog signal input. (For inputting signals coming in directly from filter circuit.)
5	IN4	I	F9	1.5kHz analog signal input. (For inputting signals coming in directly from filter circuit.)
6	IN3	I	F7	625Hz analog signal input. (For inputting signals coming in directly from filter circuit.)
7	IN2	I	F5	250Hz analog signal input. (For inputting signals coming in directly from filter circuit.)
8	IN1	I	F3	98Hz analog signal input. (For inputting signals coming in directly from filter circuit.)
9	IN0	I	F1	40Hz analog signal input. (For inputting signals coming in directly from filter circuit.)
10~13	P47~P44	O	D~A	Control signal output for Multiplexer TC74HC4028 (4 → 10)
14	P43	O	NC	Unused.
15	P42	O	DATA	Output of NJU7305 CONTROL DATA signals for electronic VR of graphic equalizer.
16	P41	O	CLOCK	Output of NJU7305 CONTROL CLOCK signals for electronic VR of graphic equalizer.
17	P40	O	ST	Output of NJU7305 CONTROL ST signals for electronic VR of graphic equalizer.
18	P37	I	SYNC	Input for transfer display data indication signals. H : DISPLAY MODE data L : LEVEL or POINT data
19	P36 (CLK)	O	CLOCK	CLOCK signal output for DISPLAY data transfer.
20	P35 (Sout)	O	DATA	DATA signal output for display.
21	P34	O	BUSY	Output for DISPLAY DATA TRANSFERRING signals. H : Data transferring L : Others
22	P33	I	READY	Input for DISPLAY DATA TRANSFERRABLE signal. H : Not transferrable L : Transferrable
23	P32	I/O	SDATA	Input/Output for SYSTEM SERIAL DATA signal.
24	P31	I/O	SBUSY	Input/Output for SYSTEM SERIAL BUSY signal.
25	P30	I	CE	BACK UP detection. H : Others L : Backing up
26	CNVss	-	Vss	Unused.
27	RESET	I	RESET	RESET signal detection. H : Others L : Reset
28	XIN	I	XIN	System clock input (4.0MHz).
29	XOUT	O	XOUT	System clock output.
30	Xcin	I	Vss	Unused. (Clock input terminal for timer.)
31	Xcout	O	NC	Unused. (Clock output terminal for timer.)
32	Vss	-		GND.
33	ø	O	NC	Unused. (Output terminal for system clock 1/4 divided frequencies.)
34~37	R3~R0	I	KR3~KR0	KEY RETURN signal input.
38	Vp	-	Vss	Pull down input.
39	P17	O	NC	Unused.
40~54	P16~P00	O	B1~B15	Output for DISPLAY TUBE SEGMENT DRIVE. H : ON L : OFF
55~57	P27~25	I	NC	Unused.
58	P24	O	AI AUTO LED	LED ON-OFF Control H : ON L : OFF
59	P23	O	AI FOCUS LED	LED ON-OFF Control H : ON L : OFF
60~62	P22~P20	O	A~C	Control signal for multiplexer TC74HC4051.
63	AVcc	-	AVcc	Power supply for A/D converter (+5V).
64	Vcc	-	Vcc	Power supply for microprocessor (+5V).

GE-850

CIRCUIT DESCRIPTION

3. Data of MEMORY EQ CURVE

(1) REFERENCE I x 5

SOFT • CLEAR • HEAVY • SCALE • NR

(2) REFERENCE II x 5 (Double-speed REC curve)

SOFT • CLEAR • HEAVY • SCALE • NR

(3) MANUAL x 5 (RESET curve at initialized)

DSP PRESENCE MODE ARENA : POPULAR or ROCK CONCERT

DSP PRESENCE MODE STADIUM : POPULAR or ROCK CONCERT

DSP PRESENCE MODE ARENA or STADIUM or CHURCH : CLASSIC CONCERT

CAR STEREO

HEAD PHONE STEREO

4) AI AUTO x 25

(I) 1 (1) : L1-H1	(II) 6 (6) : L2-H1	(III) 11 (a) : L3-H1	(IV) 16 (f) : L4-H1	(V) 21 (k) : L5-H1
2 (2) : L1-H2	7 (7) : L2-H2	12 (b) : L3-H2	17 (g) : L4-H2	22 (l) : L5-H2
3 (3) : L1-H3	8 (8) : L2-H3	13 (c) : L3-H3	18 (h) : L4-H3	23 (m) : L5-H3
4 (4) : L1-H4	9 (9) : L2-H4	14 (d) : L3-H4	19 (i) : L4-H4	24 (n) : L5-H4
5 (5) : L1-H5	10 (0) : L2-H5	15 (e) : L3-H5	20 (j) : L4-H5	25 (o) : L5-H5

(5) AI FOCUS 6 x 5

(I) ARENA x 5 (II) JAZZ CLUB x 5 (III) STADIUM x 5 (IV) DISCO x 5 (V) CHRCH x 5 (VI) MOVIE x 5

(6) AI LINK x 6

ARENA • JAZZ CLUB • STADIUM • DISCO • CHURCH • MOVIE

(7) AI TIMER1 x 2

STEP1 • STEP2

4. Test Mode

4-1. Test mode with key switch

• Setting method

1. Press the M/R key switch, connect the AC plug to an outlet. (SEGMENT Check mode)
2. Pressing the FALT key switch, connect the AC plug to an outlet. (All segments light-up mode)

• Contents of operation

- 1-1. If the mode is selected, the short check of the segment terminals is indicated. If any key switch is pressed, the device returns to the normal indication but it is kept in the test mode.
- 1-2. If the short check of the segment terminals is indicated, the bars of all the bands light up by five segments, and the lighting bars move up at the interval of 256msec. The 14-segment indicator and mode indicator on the right continue lighting in order of B15, B4, B5, B1, B2, B10, B9, B11, B6, B7, B8, B3, B14, B12, B13, B15, B4 ..

- 1-3. Set the contents of the MANUAL PRESET MEMORY as follows.

M1 : FLAT (ALL 0dB)

M2 : ALL MAX (ALL +12dB)

M3 : ALL MIN (ALL -12dB)

- 1-4. The EQ LEVEL UP/DOWN operation is set to three points of +12dB, 0dB, and -12dB at all the frequencies.
- 2-1. If the system is set to the test mode, all the indicator elements light up. If any key switch is pressed, the system returns to the normal indicating condition, but it is still in the test mode. The operation in the test mode is the same as 1-3, and 1-4.

• Resetting method of test mode and initialization

In either the key switch test mode or the serial test mode, if the AC plug is disconnected from the outlet and connected again to the outlet, the microprocessor is initialized and the power is turned off. At the same time, the test mode is reset.

CIRCUIT DESCRIPTION

5. Transfer Method

Data are transferred by the unit of 8-bits in the LSB first mode.

- SYNC is raised at the header to clearly show the divisions of the transferred data (including the header).
- $\overline{\text{READY}}$ is raised at the head of each 8-bit datum to clearly shows each division of the data.
- If any mistake is made in the transfer of data, the highest priority is given to SYNC to modify the synchronization of data.
- Data are taken in at the rise of the clock.
- BUSY is raised when data are transferred.
- Transfer is started when $\overline{\text{READY}}$ is raised.
- DATA are sent with LSB at head.

5-2. Transfer method

First, the display microprocessor notifies the transmission of the header to the main microprocessor by setting SYNC to "H". Then, it set $\overline{\text{READY}}$ to "L" to notify that it can receive data.

When the $\overline{\text{READY}}$ is set to "L", the main microprocessor checks SYNC. If SYNC is "H", the main microprocessor sends the header signal to the display microprocessor ($\overline{\text{READY}}$ returns to "H" at the first rise of the clock).

If the display microprocessor receives an 8-bit data and confirms that it is a header, it turns SYNC to "L" and also turns $\overline{\text{READY}}$ to "L" again, then demands the data from the main microprocessor.

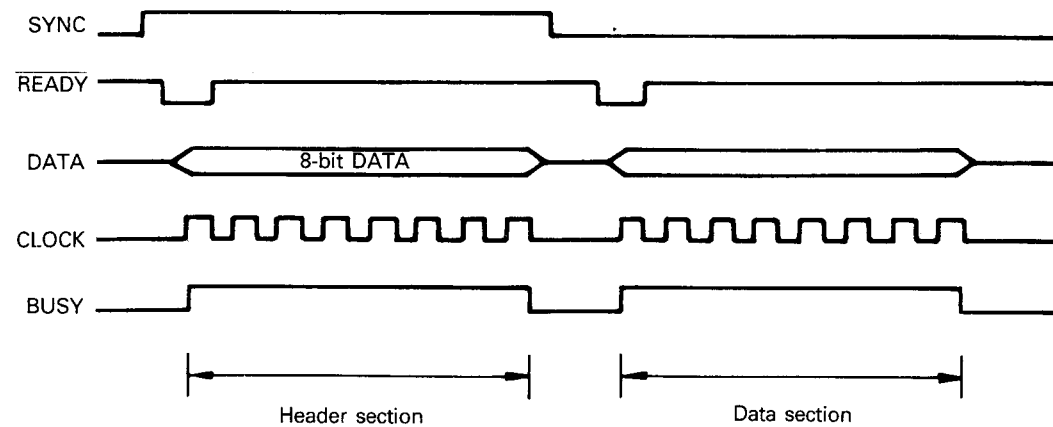

6-1. Connection

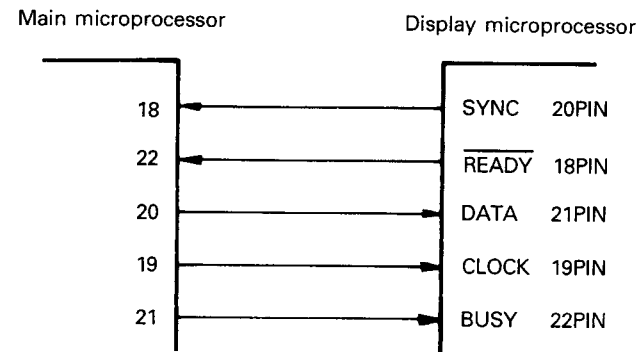

CIRCUIT DESCRIPTION

6. Display Microprocessor : M50747-F92SP (IC5 : X14-3240-21)

6-1. Terminal connection diagram

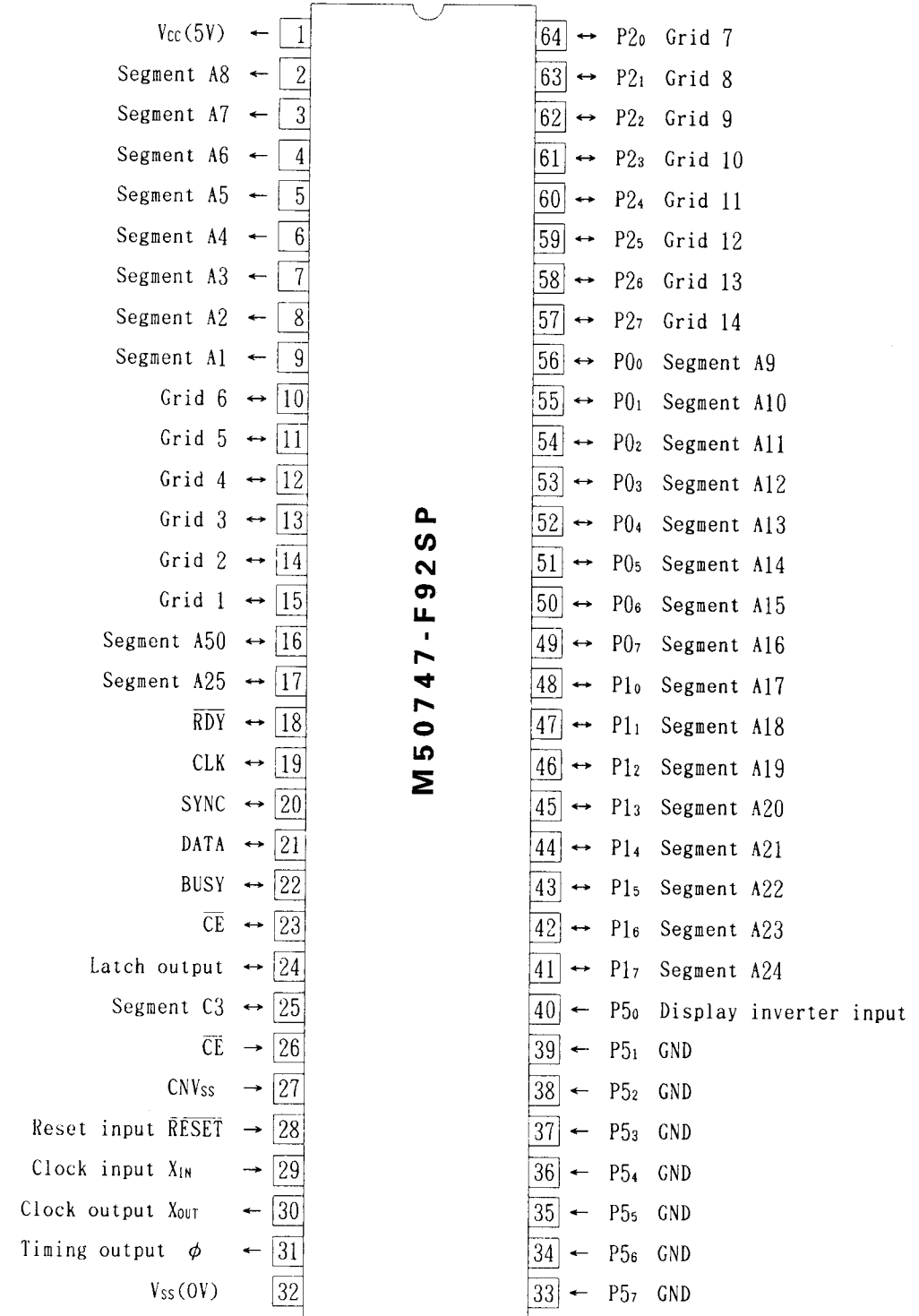

6-2. Descr

Pin No.	Pin
1	Vcc
2	P2 ₀
3	P2 ₁
4	P2 ₂
5	P2 ₃
6	P2 ₄
7	P2 ₅
8	P2 ₆
9	P2 ₇
10	P0 ₀
11	P0 ₁
12	P0 ₂
13	P0 ₃
14	P0 ₄
15	P0 ₅
16	P0 ₆
17	P0 ₇
18	P1 ₀
19	P1 ₁
20	P1 ₂
21	P1 ₃
22	P1 ₄
23	P1 ₅
24	P1 ₆
25	P1 ₇
26	IN
27	CLK
28	RESET
29	X _{IN}
30	X _{OUT}
31	ϕ
32	Vss

CIRCUIT DESCRIPTION

6. Display Microprocessor : M50747-F92SP (IC5 : X14-3240-21)

6-1. Terminal connection diagram

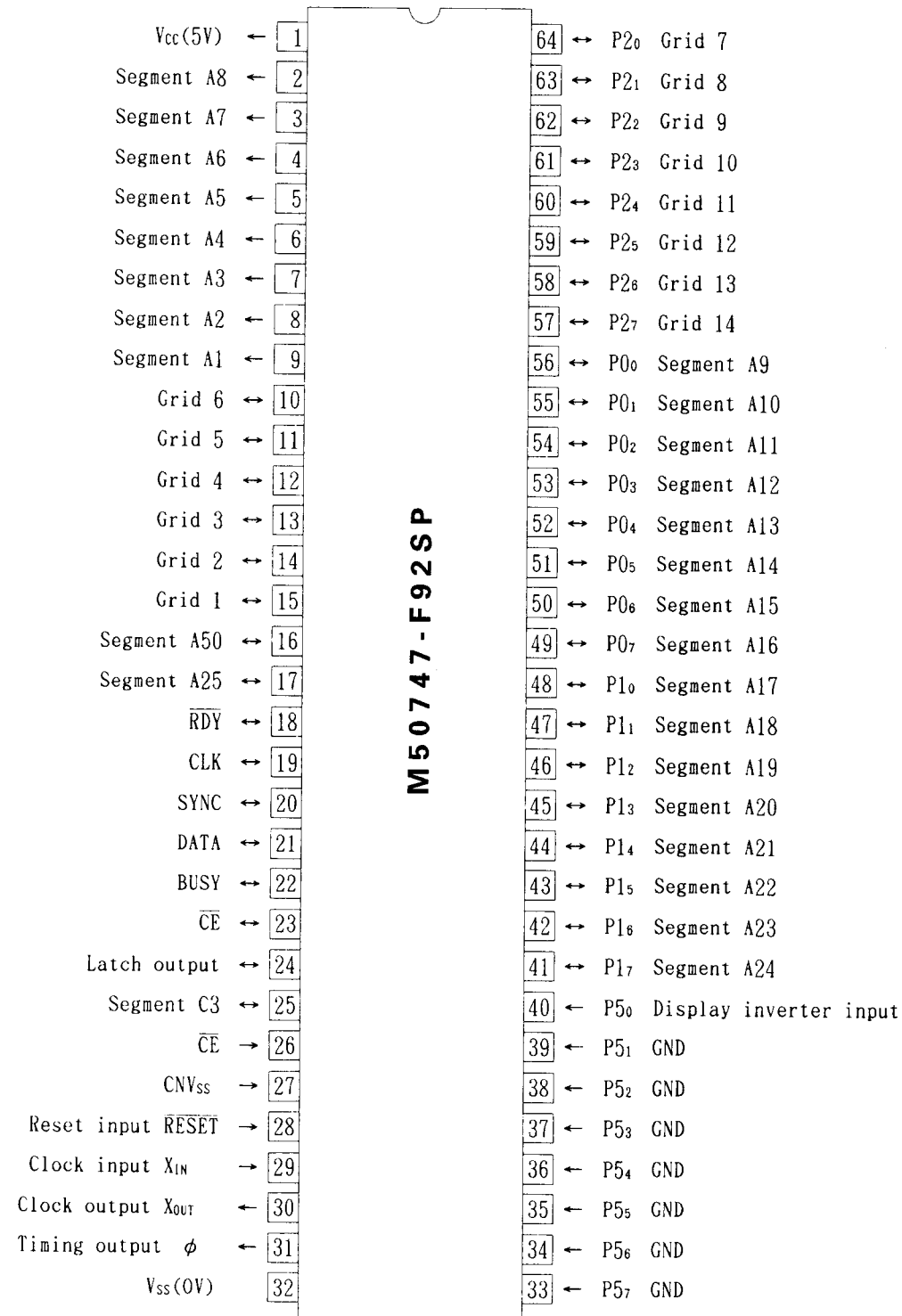

CIRCUIT DESCRIPTION

6-2. Description of terminals

Pin No.	Pin name	I/O	Name	Description
1	V _{CC}	I	5V	Power supply
2	P67	0	Segment A8	Segment
3	P66	0	Segment A7	Segment
4	P65	0	Segment A6	Segment
5	P64	0	Segment A5	Segment
6	P63	0	Segment A4	Segment
7	P62	0	Segment A3	Segment
8	P61	0	Segment A2	Segment
9	P60	0	Segment A1	Segment
10	P47	0	Grid 6	Grid
11	P46	0	Grid 5	Grid
12	P45	0	Grid 4	Grid
13	P44	0	Grid 3	Grid
14	P43	0	Grid 2	Grid
15	P42	0	Grid 1	Grid
16	P41	0	Segment A50	Segment
17	P40	0	Segment A25	Segment
18	P37	0	RDY	Serial RDY
19	P36	I	CLK	Serial CLK
20	P35	0	SYNC	Serial SYNC
21	P34	I	DATA	Serial DATA
22	P33	I	BUSY	Serial BUSY
23	P32	I	CE	Chip inable
24	P31	0	LATCH OUT	74HC77 latch control
25	P30	0	Segment C3	Segment
26	INT1	0	CE	Chip inable
27	CNV _{ss}	I	CNV _{ss}	GND
28	RESET	I	RESET	RESET
29	X _{IN}	I	X _{IN}	Clock
30	X _{OUT}	0	X _{OUT}	Clock
31	φ	0	φ	Timing signal φ output
32	V _{SS}	I	V _{SS}	GND

Pin No.	Pin name	I/O	Name	Description
33	P57	I	P57	GND
34	P56	I	P56	GND
35	P55	I	P55	GND
36	P54	I	P54	GND
37	P53	I	P53	GND
38	P52	I	P52	GND
39	P51	I	P51	GND
40	P50	I	Invert	Display invert input
41	P17	0	Segment A24	Segment
42	P16	0	Segment A23	Segment
43	P15	0	Segment A22	Segment
44	P14	0	Segment A21	Segment
45	P13	0	Segment A20	Segment
46	P12	0	Segment A19	Segment
47	P11	0	Segment A18	Segment
48	P10	0	Segment A17	Segment
49	P07	0	Segment A16	Segment
50	P06	0	Segment A15	Segment
51	P05	0	Segment A14	Segment
52	P04	0	Segment A13	Segment
53	P03	0	Segment A12	Segment
54	P02	0	Segment A11	Segment
55	P01	0	Segment A10	Segment
56	P00	0	Segment A9	Segment
57	P27	0	Grid 14	Grid
58	P26	0	Grid 13	Grid
59	P25	0	Grid 12	Grid
60	P24	0	Grid 11	Grid
61	P23	0	Grid 10	Grid
62	P22	0	Grid 9	Grid
63	P21	0	Grid 8	Grid
64	P20	0	Grid 7	Grid

PC BOARD (COMPONENT SIDE VIEW)

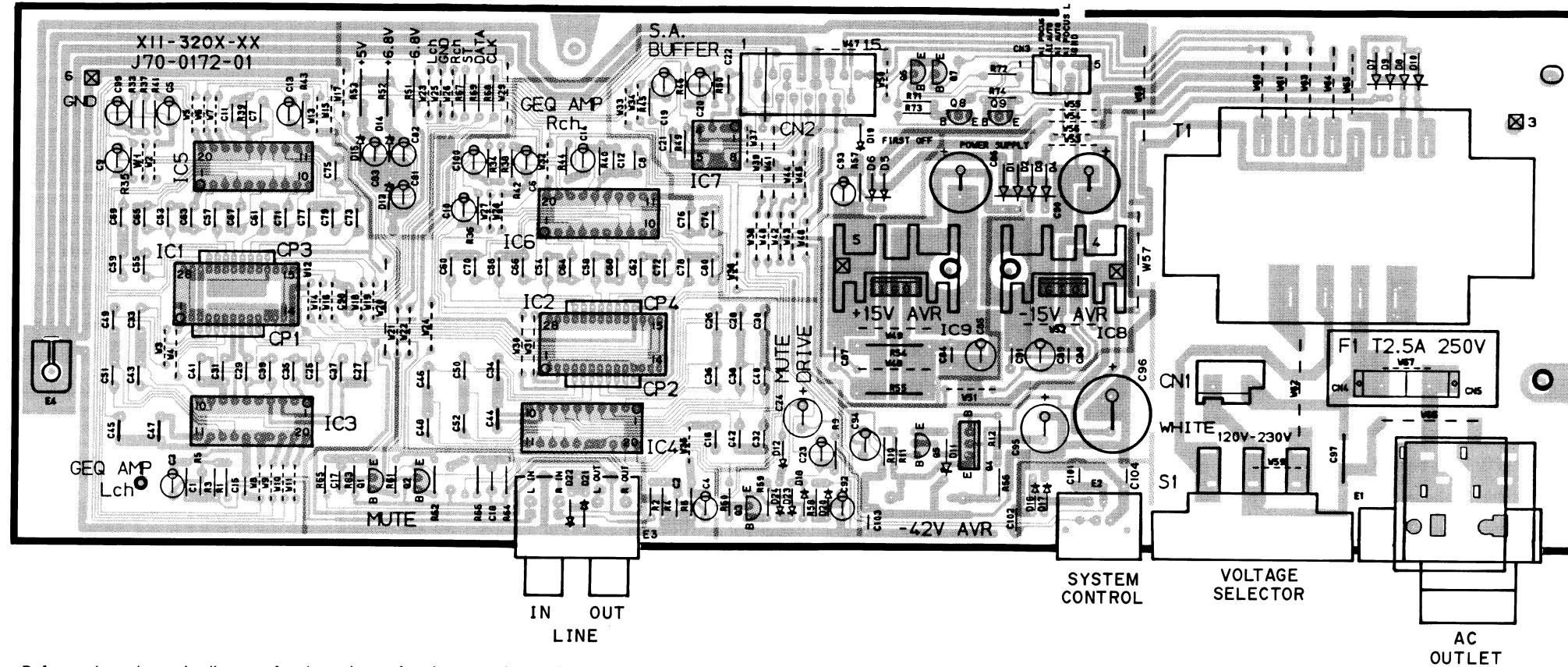

Refer to the schematic diagram for the values of resistors and capacitors.

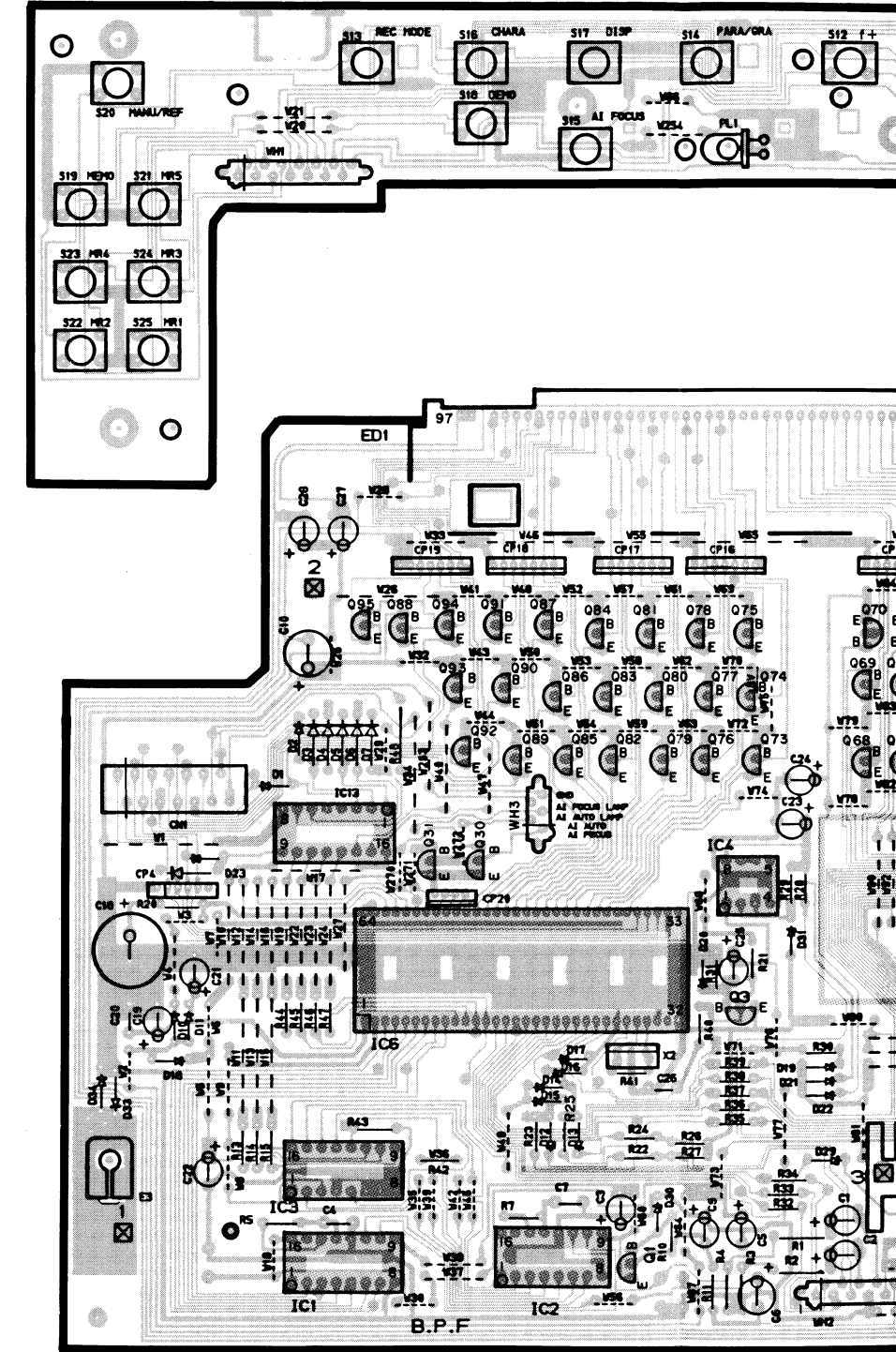

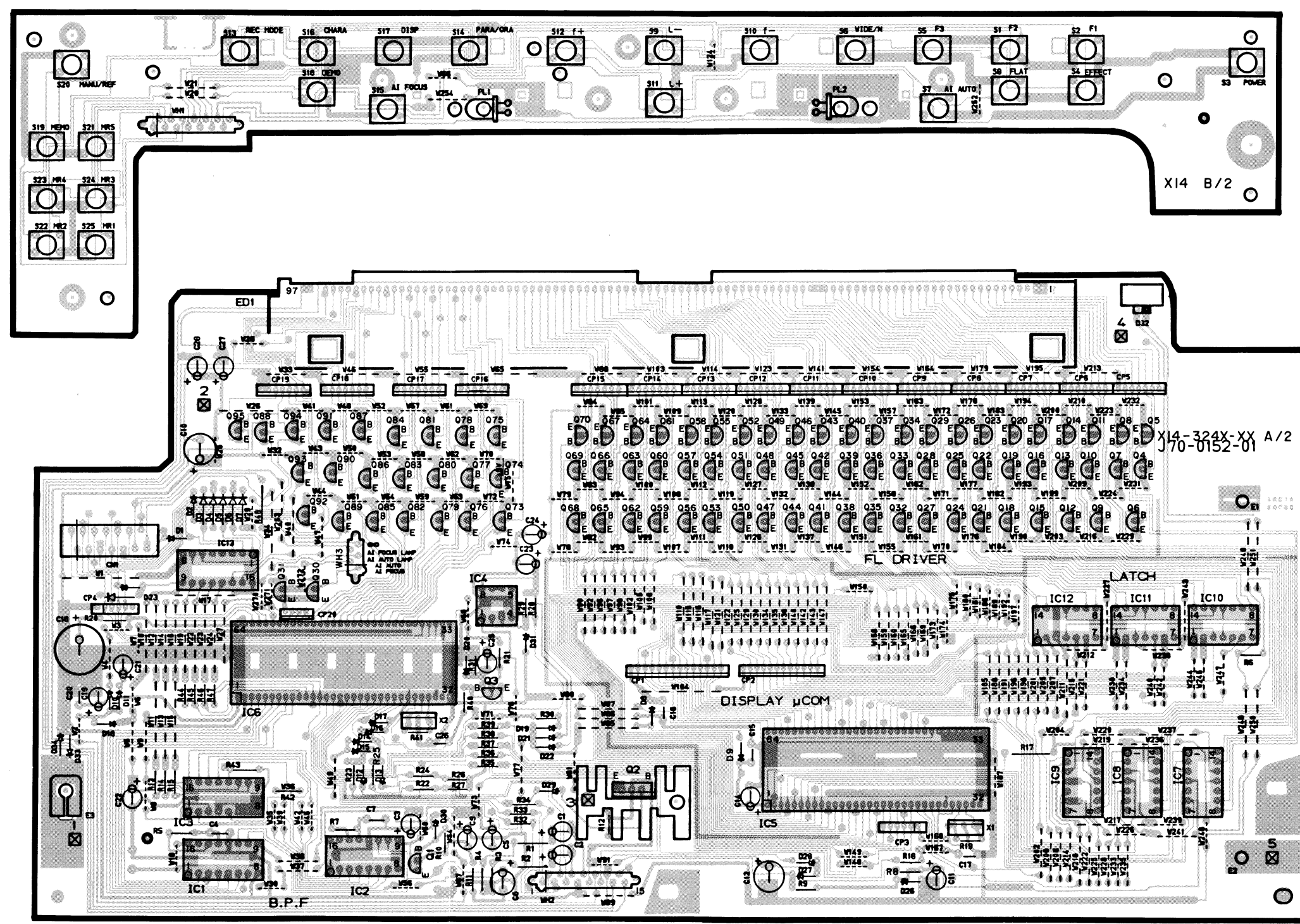
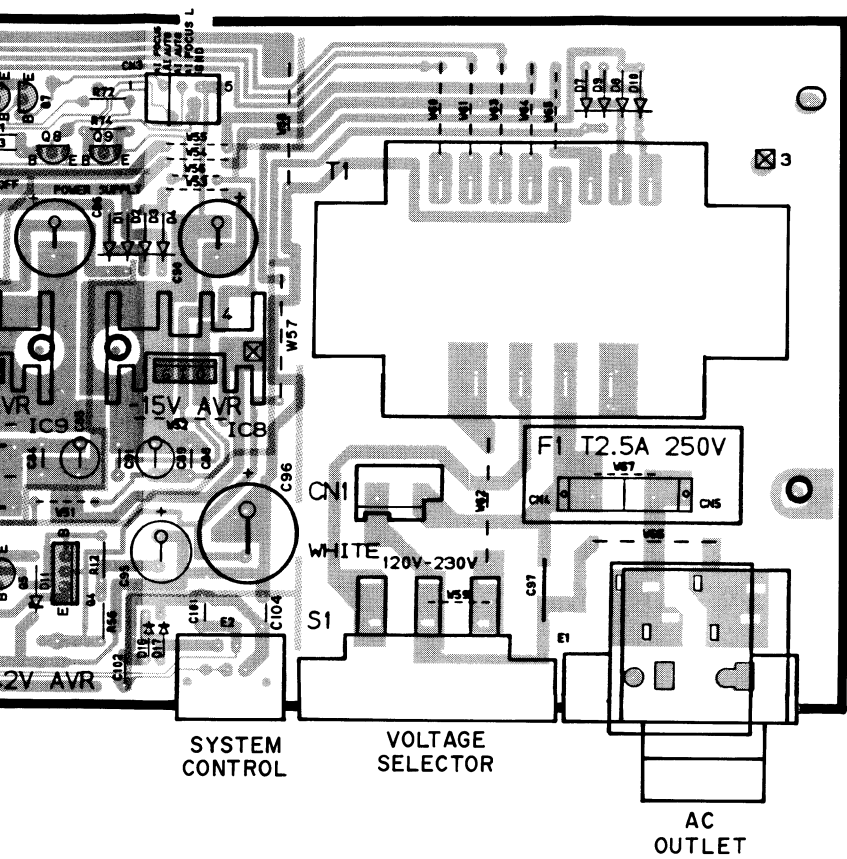

X14 B/2

X14-324X-XX A/2
70-0152-01

CONTROL UNIT
(X11-3202-71)

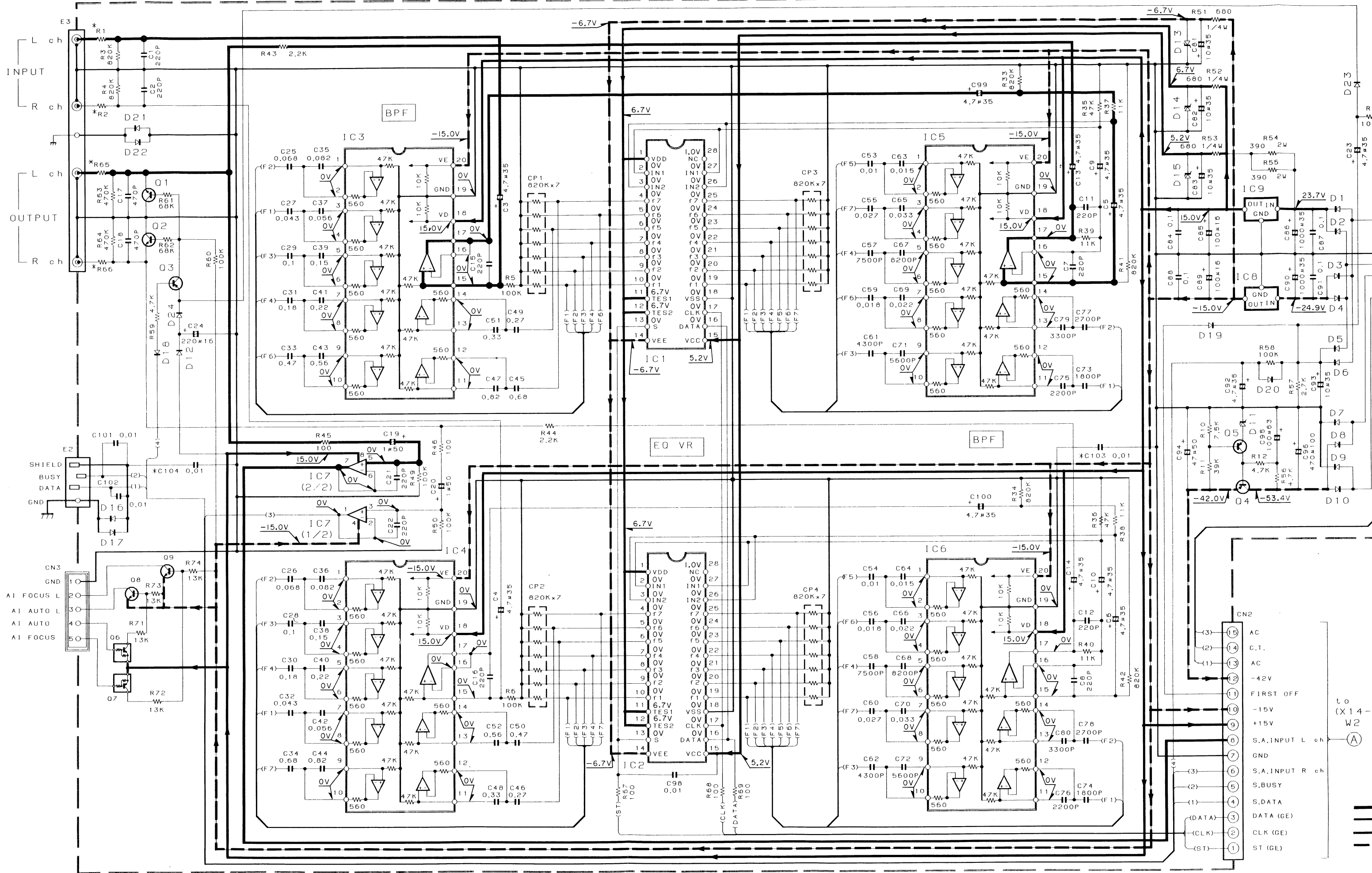

(15)	AC
(14)	C.T.
(13)	AC
(12)	-42V
(11)	FIRST OFF
(10)	-15V
(9)	+15V
(8)	S.A.INPUT L ch
(7)	GND
(6)	S.A.INPUT R ch
(5)	S.BUSY
(4)	S.DATA
(3)	DATA (GE)
(2)	CLK (GE)
(1)	ST (GE)

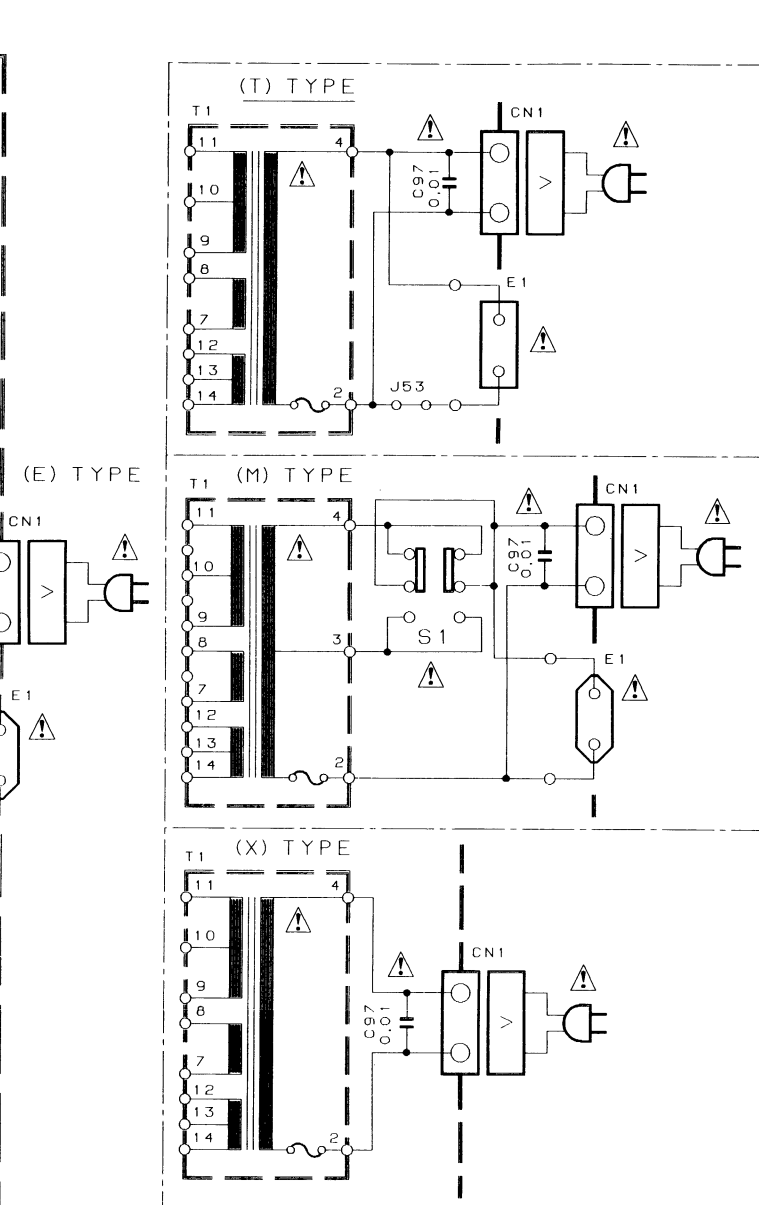
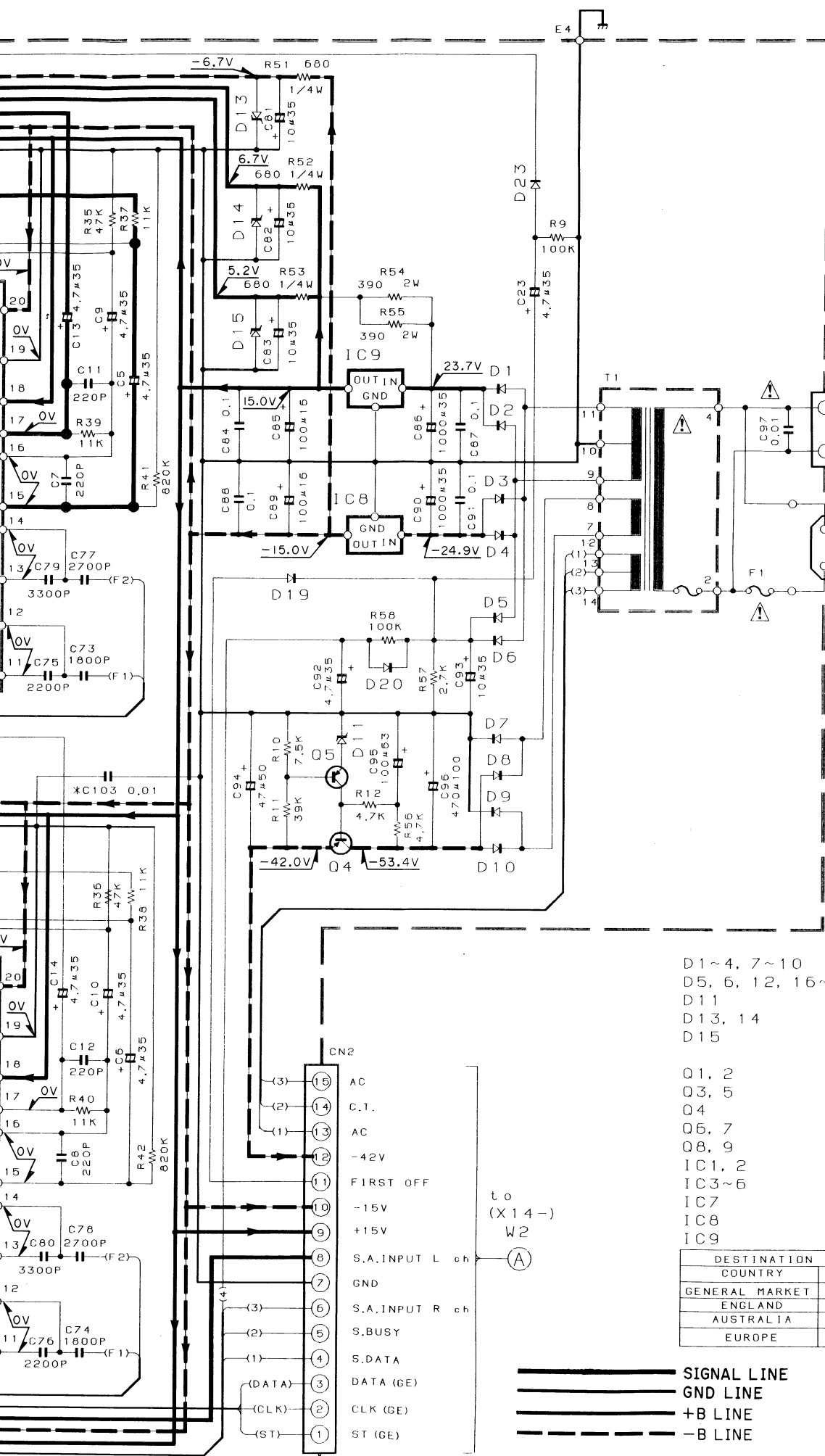

- D1~4, 7~10 : S5688B or 1SR139-100
 D5, 6, 12, 16~24 : HSS104A or 1SS131
 D11 : RD6.2ES (B2) or HZS6.2N (B2)
 D13, 14 : RD6.8 ES (B2) or HZS6.8 N (B2)
 D15 : RD5.1 ES (B2) or HZS5.1 N (B2)

- Q1, 2 : 2SC2878 (B)
 Q3, 5 : 2SA933S (Q, R) or 2SA1309A (Q, R)
 Q4 : 2SB941
 Q6, 7 : UN4112 or DTA124ES
 Q8, 9 : 2SC3246
 IC1, 2 : NJU7305L
 IC3~6 : M5229P
 IC7 : NJM4558D
 IC8 : μPC7915HF
 IC9 : μPC7815HF

DESTINATION COUNTRY	ABB.	UNIT NAME	R1, 2	R65, 66	C103, 104
GENERAL MARKET	M	X11-3200-21			
ENGLAND	T	X11-3200-51	100	100	NO
AUSTRALIA	X	X11-3200-71			
EUROPE	E	X11-3202-71	470	1.5K	YES

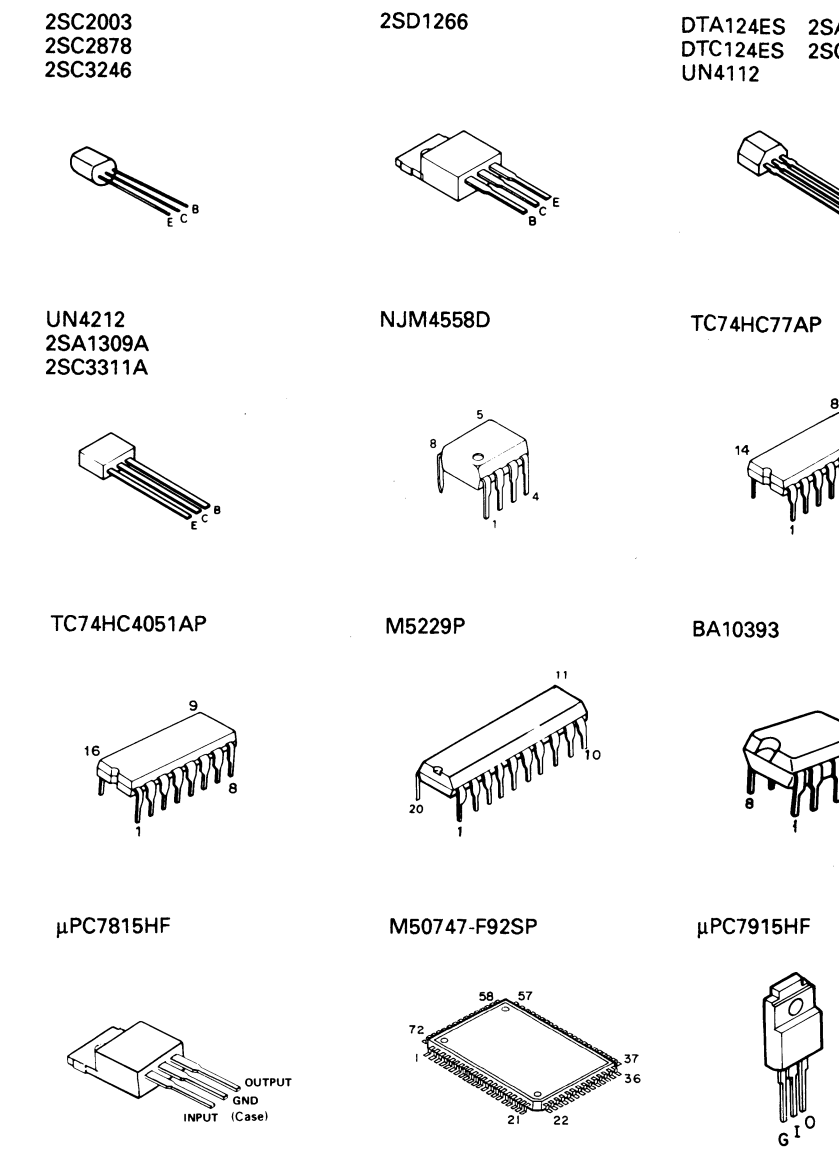
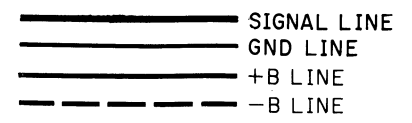

CAUTION : For continued safety, replace safety critical components only with manufacturer's recommended parts (refer to parts list). ⚠ Indicates safety critical components. To reduce the risk of electric shock, leakage-current or resistance measurements shall be carried out (exposed parts are acceptably insulated from the supply circuit) before the appliance is returned to the customer.

• DC voltages between input and output terminals. V between input and output terminals.

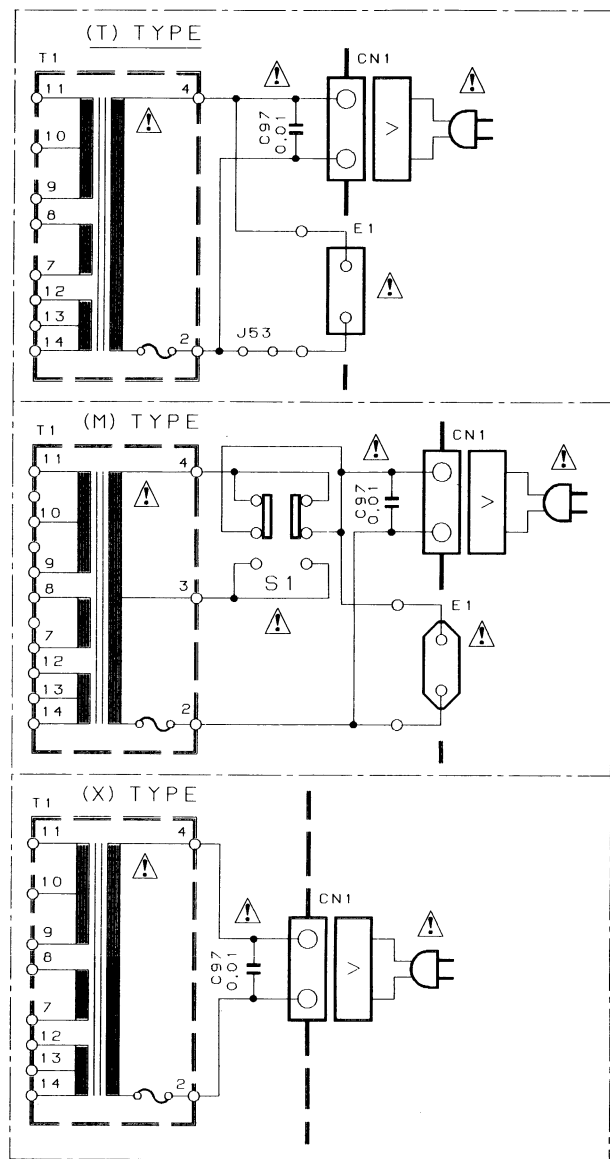
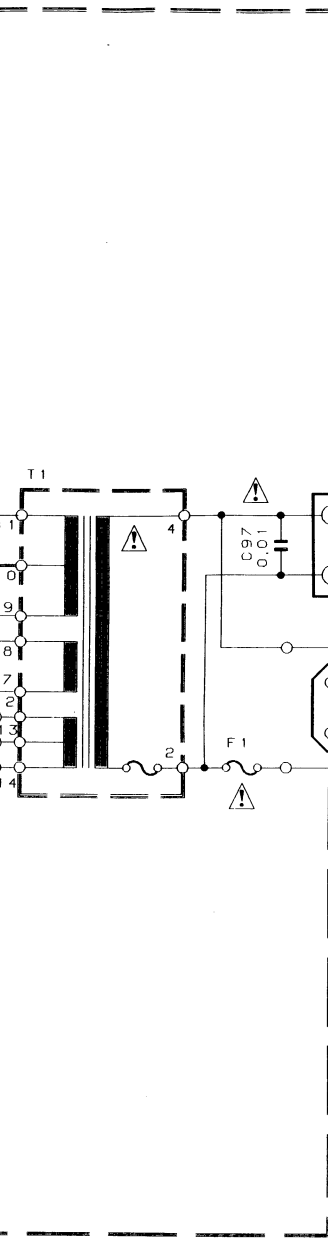

- D1~4, 7~10 : S5688B or 1SR139-100
 D5, 6, 12, 16~24 : HSS104A or 1SS131
 D11 : RD6.2ES (B2) or HZS6.2N (B2)
 D13, 14 : RD6.8 ES (B2) or HZS6.8 N (B2)
 D15 : RD5.1 ES (B2) or HZS5.1 N (B2)
- Q1, 2 : 2SC2878 (B)
 Q3, 5 : 2SA933S (Q, R) or 2SA1309A (Q, R)
 Q4 : 2SB941
 Q6, 7 : UN4112 or DTA124ES
 Q8, 9 : 2SC3246
 IC1, 2 : NJU7305L
 IC3~6 : M5229P
 IC7 : NJM4558D
 IC8 : μPC7915HF
 IC9 : μPC7815HF

DESTINATION COUNTRY	ABB.	UNIT NAME	R1, 2	R65, 66	C103, 104
GENERAL MARKET	M	X11-3200-21			
ENGLAND	T	X11-3200-51	100	100	NO
AUSTRALIA	X	X11-3200-71			
EUROPE	E	X11-3202-71	470	1.5K	YES

— SIGNAL LINE
 — GND LINE
 — +B LINE
 - - - -B LINE

GE-850 (E) 1/2

2SC2003
 2SC2878
 2SC3246

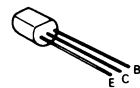

UN4212
 2SA1309A
 2SC3311A

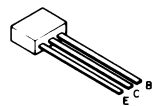

TC74HC4051AP

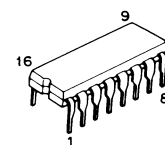

μPC7815HF

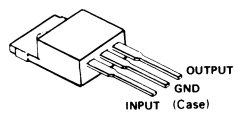

2SD1266

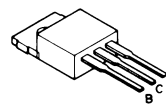

NJM4558D

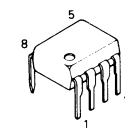

M5229P

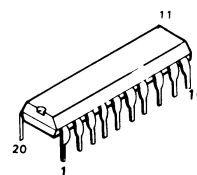

M50747-F92SP

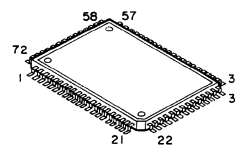

DTA124ES 2SA933S
 DTC124ES 2SC1740S
 UN4112

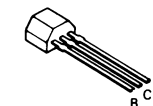

TC74HC77AP

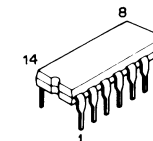

BA10393

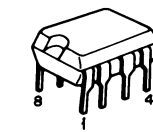

μPC7915HF

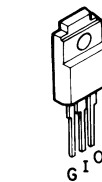

2SB941



XR-1091DCP

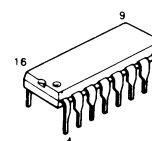

NJU7305L

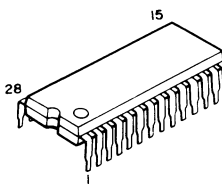

CAUTION : For continued safety, replace safety critical components only with manufacturer's recommended parts (refer to parts list). ⚠ Indicates safety critical components. To reduce the risk of electric shock, leakage-current or resistance measurements shall be carried out (exposed parts are acceptably insulated from the supply circuit) before the appliance is returned to the customer.

• DC voltages are as measured with a high impedance voltmeter. Values may vary slightly due to variations between individual instruments or/and units.

GE-850
KENWOOD

Y09-3880-21

SWITCH UNIT
(X14-3240-21) (B/2)

DISPLAY UNIT
(X14-3240-21) (A/2)

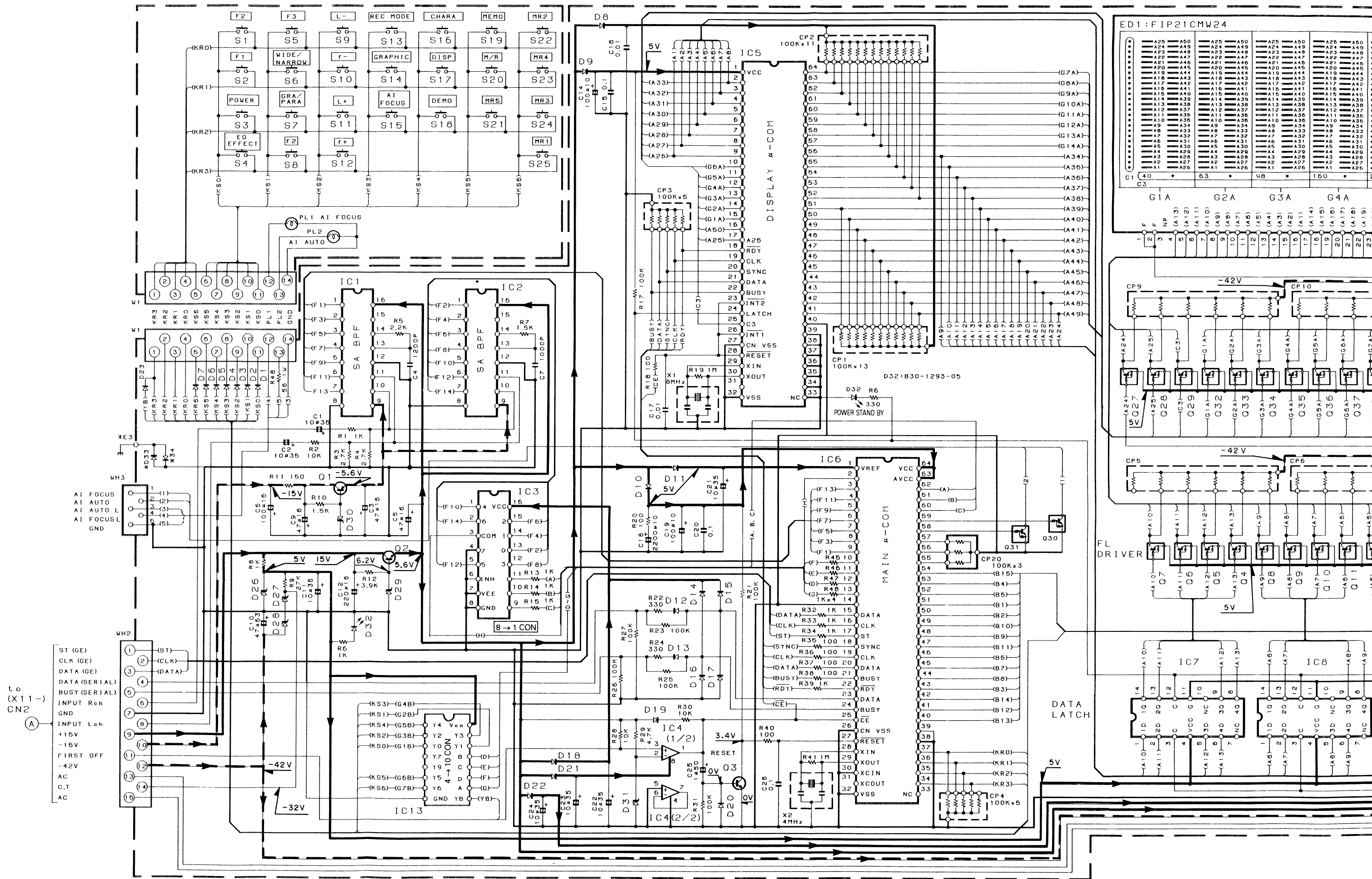

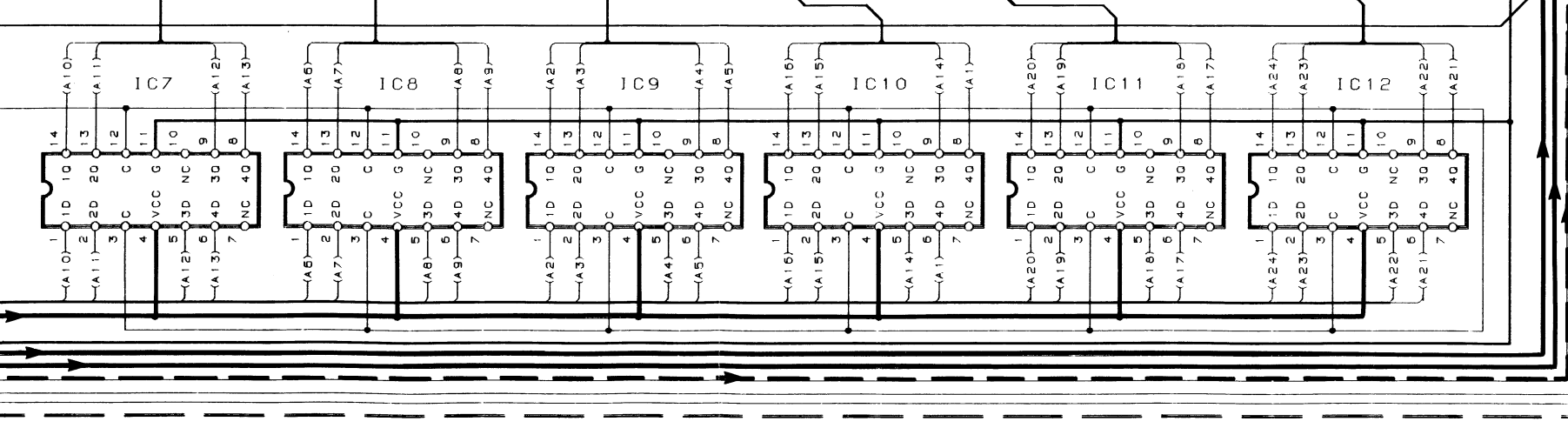
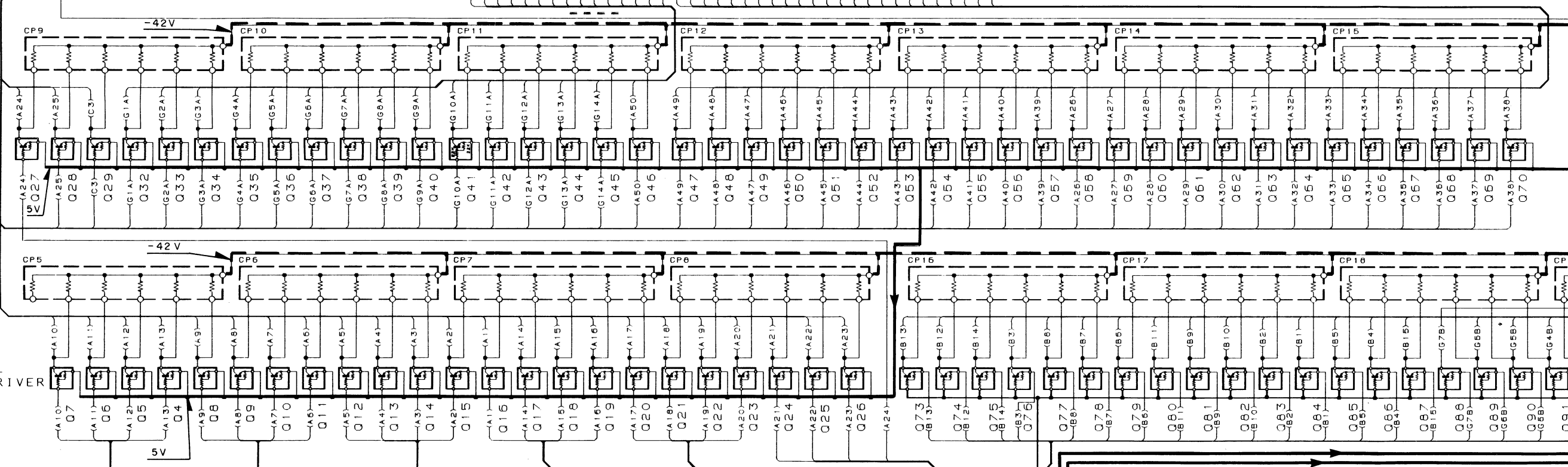
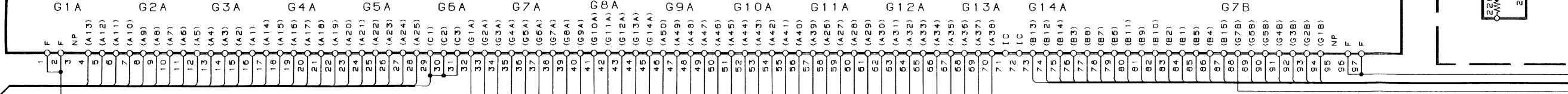
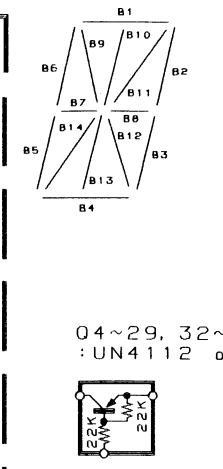
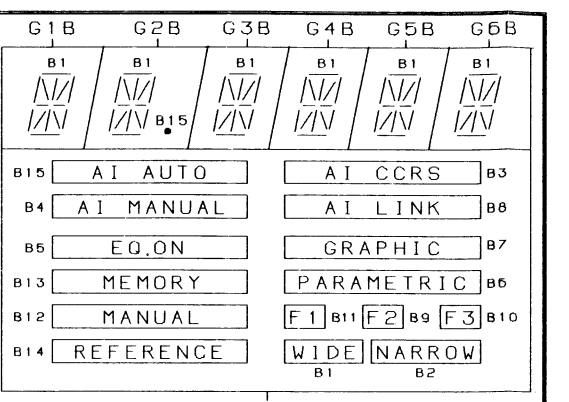
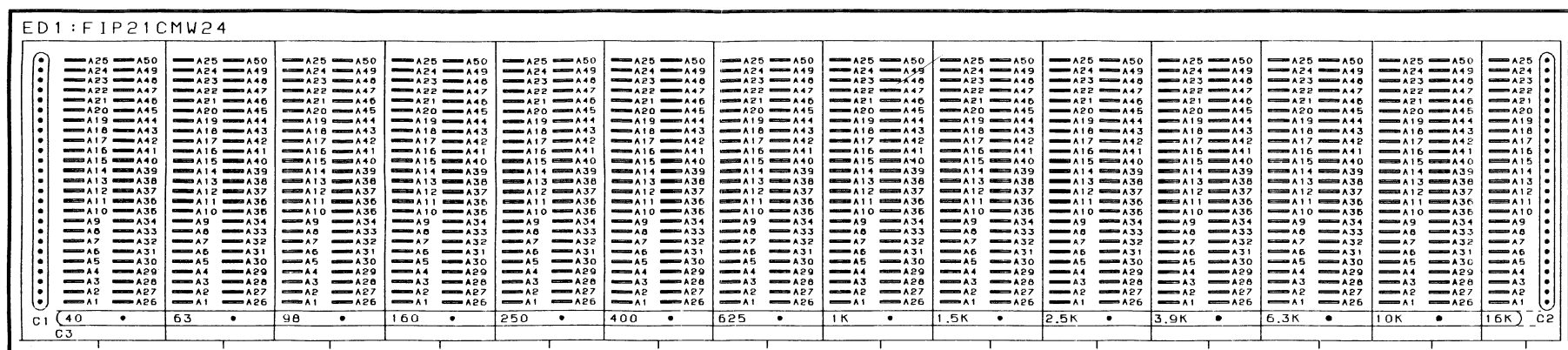
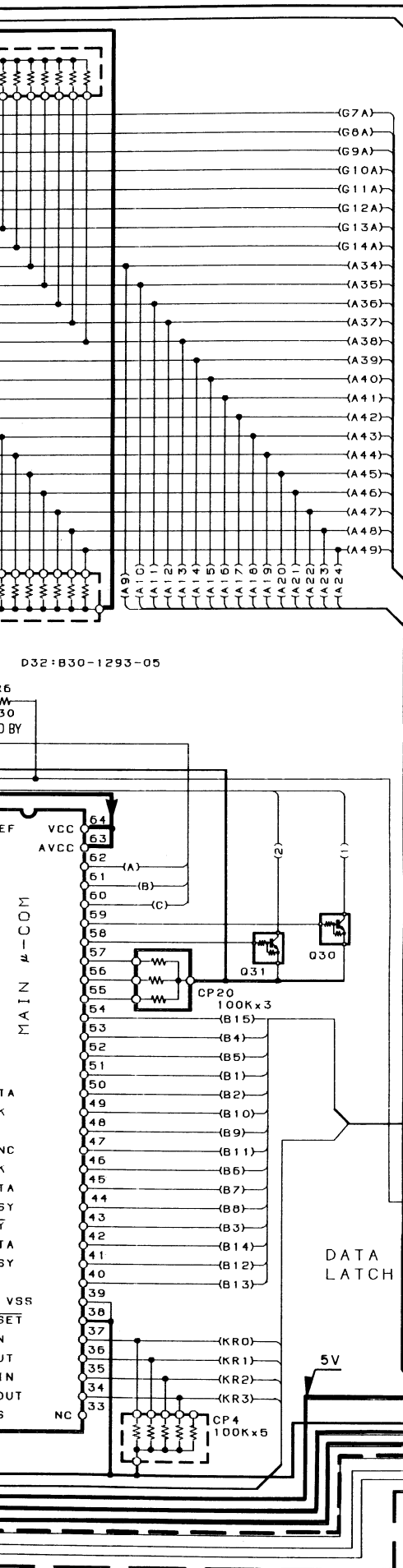

- Q1 : 2SA933S (O, R) or 2SA1309A (O, R)
- Q2 : 2SD1266 (O, P)
- Q3 : 2SC1740S (O, R) or 2SC3311A (O, R)
- Q4~29, 32~70, 73~94 : UN4112 or DTA124ES
- Q95 : 2SC2003 (L, K)
- Q30, 31 : DTC124ES or UN4212
- D1~23, 33, 34 : HSS104 or 1SS133
- D26 : RD5.1ES (B2) or HZS5.1N (B2)
- D27, 28 : RD4.7ES (B) or HZS4.7N (B)
- D29, 30 : RD6.2ES (B2) or HZS6.2N (B2)
- D31 : RD3.9ES (B2) or HZS3.9N (B2)
- IC13 : TC74HC4028AP
- IC1, 2 : XR-1091DCP
- IC3 : TC74HC4051AP
- IC4 : BA10393
- IC5 : M50747-F92SP
- IC6 : M50945-104SP
- IC7~12 : TC74HC77AP

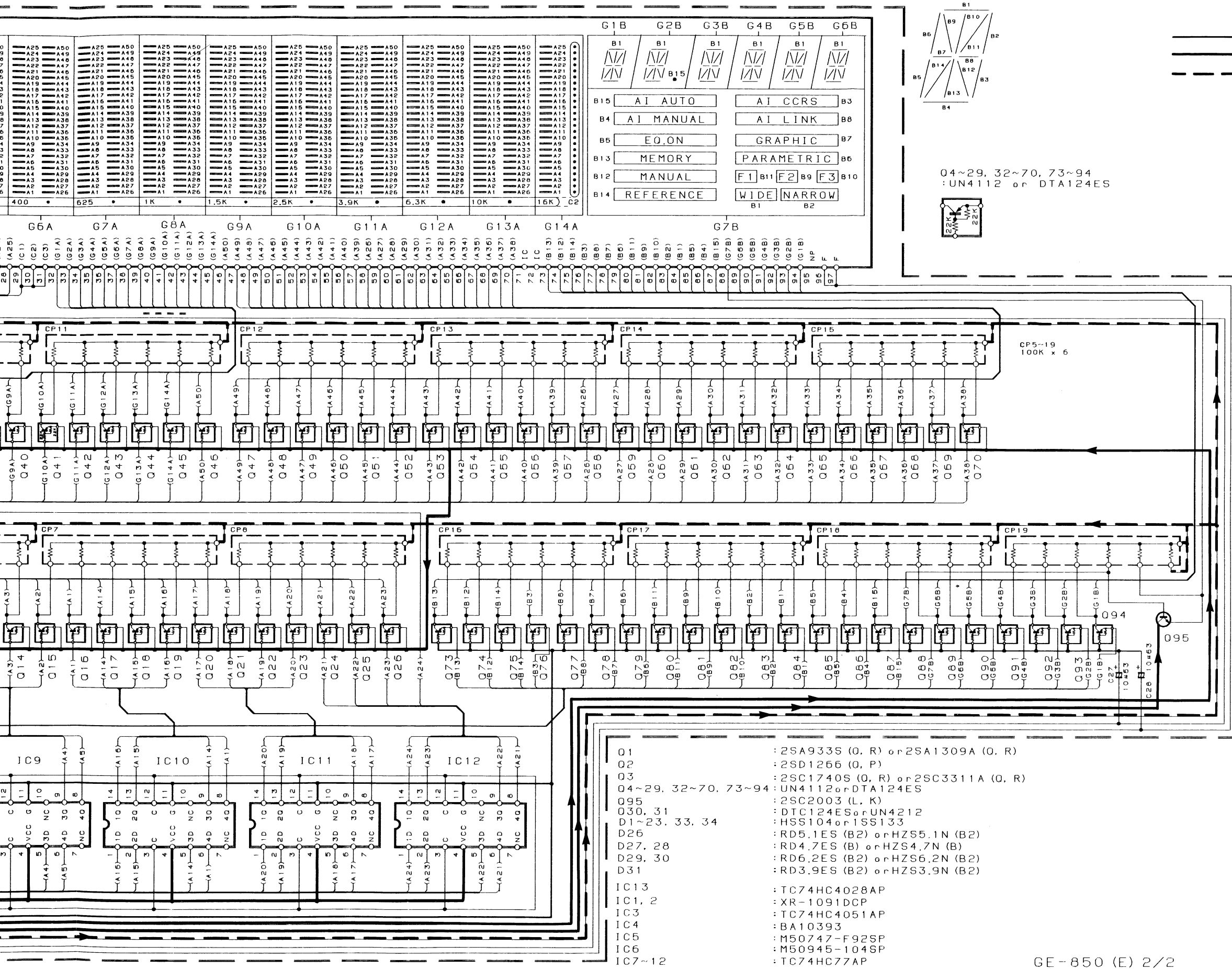

- 01 : 2SA933S (0, R) or 2SA1309A (0, R)
- 02 : 2SD1266 (0, P)
- 03 : 2SC1740S (0, R) or 2SC3311A (0, R)
- 04~29, 32~70, 73~94 : UN4112 or DTA124ES
- 095 : 2SC2003 (L, K)
- 030, 31 : DTC124ES or UN4212
- D1~23, 33, 34 : HSS104 or 155133
- D26 : RD5.1ES (B2) or HZS5.1N (B2)
- D27, 28 : RD4.7ES (B) or HZS4.7N (B)
- D29, 30 : RD6.2ES (B2) or HZS6.2N (B2)
- D31 : RD3.9ES (B2) or HZS3.9N (B2)
- IC13 : TC74HC4028AP
- IC1, 2 : XR-1091DCP
- IC3 : TC74HC4051AP
- IC4 : BA10393
- IC5 : M50747-F92SP
- IC6 : M50945-104SP
- IC7~12 : TC74HC77AP

GE-850 (E) 2/2

CAUTION : For continued safety, replace safety critical components only with manufacturer's recommended parts (refer to parts list). Δ Indicates safety critical components. To reduce the risk of electric shock, leakage-current or resistance measurements shall be carried out (exposed parts are acceptably insulated from the supply circuit) before the appliance is returned to the customer.

• DC voltages are as measured with a high impedance voltmeter. Values may vary slightly due to variations between individual instruments or/and units.



Y09-3880-21

EXPLODED VIEW

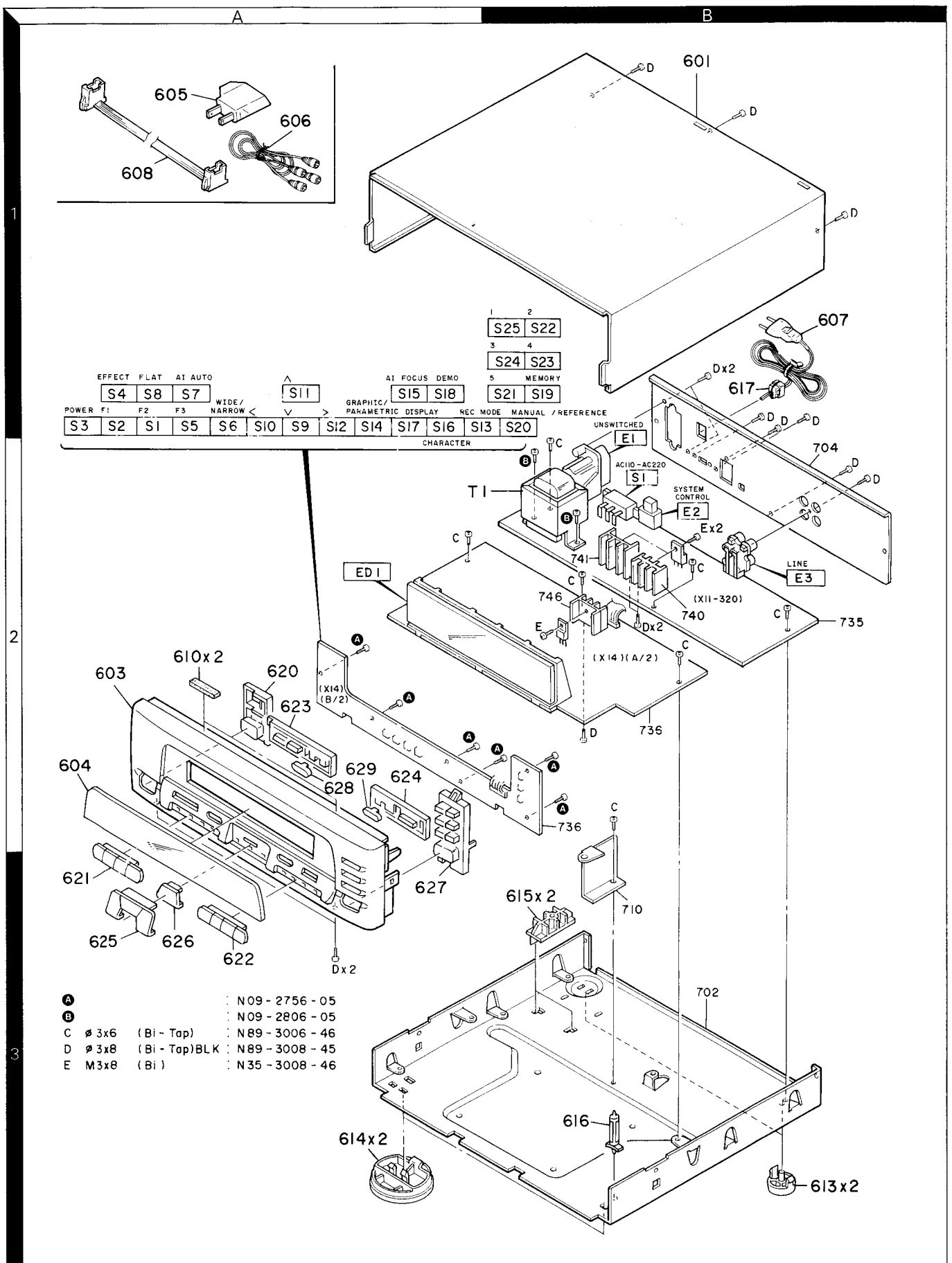

Parts with the exploded numbers larger than 700 are not supplied.

GE-850

PARTS LIST

* New Parts
Parts without Parts No. are not supplied.
Les articles non mentionnés dans le Parts No. ne sont pas fournis.
Teile ohne Parts No. werden nicht geliefert.

24

Ref. No. 参照番号	Address 位置	Parts No. 部品番号	Description 部品名 / 規格	Re- marks 備考
GE-850				
601	1B	A01-1826-01	METALLIC CABINET	
603	2A	A60-0125-01	PANEL	
604	2A	B10-1895-03	FRONT GLASS	X
-	-	B46-0096-23	WARRANTY CARD	E
-	-	B46-0129-13	WARRANTY CARD	T
-	-	B46-0143-13	WARRANTY CARD	
-	-	B60-0588-00	INSTRUCTION MANUAL (ENGLISH)	
-	-	B60-0589-00	INSTRUCTION MANUAL (F/G/D/I)	E
-	-	B60-0590-00	INSTRUCTION MANUAL (SPANISH)	M
-	-	B60-0591-00	INSTRUCTION MANUAL (CHINESE)	M
605	1A	E03-0115-05	AC PLUG ADAPTER	M
606	1A	E30-0505-05	AUDIO CORD	ME
607	1B	E30-2592-15	AC POWER CORD	X
607	1B	E30-2594-15	AC POWER CORD	T
607	1B	E30-2602-05	AC POWER CORD	
608	1A	E30-2628-05	CORD WITH CONNECTOR	
610	2A	G11-0191-04	SOFT TAPE (90X5X2.5)	
-	-	H10-5210-02	POLYSTYRENE FOAMED FIXTURE(L)	
-	-	H10-5211-02	POLYSTYRENE FOAMED FIXTURE(R)	
-	-	H25-0224-04	PROTECTION BAG (800X400X0.03)	
-	-	H25-0232-04	PROTECTION BAG (235X350X0.03)	
-	-	H50-0159-04	ITEM CARTON CASE	
613	3B	J02-0370-05	FOOT (BACK)	
614	3A	J02-1040-05	FOOT (FRONT)	
615	3B	J19-3314-04	HOLDER	
616	3B	J19-3331-05	UNIT HOLDER	
617	1B	J42-0083-05	POWER CORD BUSHING	
620	2A	K29-4262-02	KNOB (POWER)	
621	3A	K29-4263-02	KNOB (F1-WIDE/NARROW)	
622	3A	K29-4264-02	KNOB (GRAPHIC/REC. MODE)	
623	2A	K29-4265-02	KNOB (EFFECT/FLAT)	
624	2A	K29-4266-02	KNOB (DEMO)	
625	3A	K29-4267-02	KNOB (UP)	
626	3A	K29-4268-02	KNOB (DOWN)	
627	3A	K29-4269-02	KNOB (1-5/MEMORY)	
628	2A	K29-4270-03	KNOB (AI AUTO)	
629	2A	K29-4271-03	KNOB (AI FOCUS)	
T1	2A	L07-0184-05	POWER TRANSFORMER	
A		N09-2756-05	TAPTITE SCREW (2.6X10)	
B		N09-2805-05	TAPTITE SCREW	
C		N89-5008-46	BINDING HEAD TAPTITE SCREW	
D		N89-5008-45	BINDING HEAD TAPTITE SCREW	
CONTROL (X11-3202-71)				
C1	12	CC45FSL1H221J	CERAMIC	J
C3	6	CE04KW1V4R7M	ELECTRO	35W
C7	8	CC45FSL1H221J	CERAMIC	J
C9	10	CE04KW1V4R7M	ELECTRO	35W
C11	12	CC45FSL1H221J	CERAMIC	J
C13	14	CE04KW1V4R7M	ELECTRO	4.7UF 35WV
C15	16	CC45FSL1H221J	CERAMIC	220PF J

L:Scandinavia K:USA P:Canada
Y:FX(Far East, Hawaii) T:England E:Europe
Y:AF(E:Europe) X:Australia M:Other Areas
A indicates safety critical components

* New Parts
Parts without Parts No. are not supplied.
Les articles non mentionnés dans le Parts No. ne sont pas fournis.
Teile ohne Parts No. werden nicht geliefert.

Ref. No. 参照番号	Address 位置	Parts No. 部品番号	Description 部品名 / 規格	Re- marks 備考
C17	18	CK45EB1H471K	CERAMIC	
C19	20	CE04KW1H010M	ELECTRO	K
C21	22	CC45FSL1H221J	CERAMIC	J
C23	22	CE04KW1V4R7M	ELECTRO	4.7UF 35WV
C24	22	CE04KW1C221M	ELECTRO	220UF 16WV
C25	26	CF92FV1H683J	MF	J
C27	27	CF92FV1H433J	MF	0.043UF J
C28	29	CF92FV1H104J	MF	0.10UF J
C30	31	CF92FV1H184J	MF	0.18UF J
C32	31	CF92FV1H433J	MF	0.043UF J
C33	33	CF92FV1H474J	MF	J
C34	33	CF92FV1H684J	MF	0.68UF J
C35	36	CF92FV1H823J	MF	0.082UF J
C37	39	CF92FV1H563J	MF	0.056UF J
C38	39	CF92FV1H154J	MF	0.15UF J
C40	41	CF92FV1H224J	MF	0.22UF J
C42	42	CF92FV1H563J	MF	0.056UF J
C43	43	CF92FV1H564J	MF	0.56UF J
C44	44	CF92FV1H824J	MF	0.82UF J
C45	45	CF92FV1H684J	MF	0.68UF J
C46	46	CF92FV1H274J	MF	0.27UF J
C47	47	CF92FV1H824J	MF	0.82UF J
C48	48	CF92FV1H334J	MF	0.33UF J
C49	49	CF92FV1H274J	MF	0.27UF J
C50	50	CF92FV1H474J	MF	0.47UF J
C51	51	CF92FV1H334J	MF	0.33UF J
C52	52	CF92FV1H564J	MF	0.56UF J
C53	54	C91-0676-05	CERAMIC	K
C55	54	CF92FV1H273J	MF	0.027UF J
C56	56	C91-0682-05	CERAMIC	K
C57	58	C992FM1H752J	MYLAR	J
C59	60	C91-0682-05	CERAMIC	K
C60	60	CF92FV1H273J	MF	0.027UF J
C61	62	C992FM1H432J	MYLAR	J
C63	64	C91-0680-05	CERAMIC	K
C65	65	CF92FV1H333J	MF	0.033UF J
C66	66	C91-0684-05	CERAMIC	K
C67	68	C992FM1H822J	MYLAR	J
C69	68	C91-0684-05	CERAMIC	K
C70	70	CF92FV1H333J	MF	0.033UF J
C71	72	C992FM1H562J	MYLAR	J
C73	74	C91-0658-05	CERAMIC	K
C75	76	C91-0660-05	CERAMIC	K
C77	78	C91-0662-05	CERAMIC	K
C79	80	C91-0664-05	CERAMIC	K
C81	83	CE04KW1V100M	ELECTRO	35WV
C84	84	CF92FV1H104J	MF	0.10UF J
C85	85	CE04KW1C101M	ELECTRO	100UF 16WV
C86	86	CE04KW1V102M	ELECTRO	1000UF 35WV
C87	88	CF92FV1H104J	MF	0.10UF J
C89	90	CE04KW1C101M	ELECTRO	100UF 16WV
C90	10	CE04KW1V102M	ELECTRO	1000UF 35WV
C91	12	CF92FV1H104J	MF	0.10UF J
C92	14	CE04KW1V4R7M	ELECTRO	4.7UF 35WV
C93	16	CE04KW1V100M	ELECTRO	100UF 35WV

L:Scandinavia K:USA P:Canada
Y:FX(Far East, Hawaii) T:England E:Europe
Y:AF(E:Europe) X:Australia M:Other Areas
A indicates safety critical components

PARTS LIST

* New Parts
 Parts without Parts No. are not supplied.
 Les articles non mentionnés dans le Parts No. ne sont pas fournis.
 Teile ohne Parts No. werden nicht geliefert.

4

Ref. No. 参照番号	Address 位置	New Parts 新	Parts No. 部品番号	Description 部品名 / 規格	Desti- nation 仕	Re- marks 備考
DISPLAY (X14-3240-21)						
D32			B30-1293-05	LED LAMP		
PL1 , 2		*	B30-2406-05			
C1 , 2			CE04KW1V100M	10UF		
C3			CE04KW1C470M	35KV		
C4			C92FM1H122J	47UF		
C5			CE04KW1C470M	1200PF		
C6			CE04KW1C101M	47UF		
C7			C92FM1H102J	1000PF		
C9			CE04KW1C470M	47UF		
C10			CE04KW1J470M	47UF		
C11			CE04KW1V100M	35KV		
C12			CE04KW1C221M	2200UF		
C14			CE04KW1A101M	100UF		
C15			CF92FV1H104J	0.10UF		
C16 , 17			C92FM1H103J	0.010UF		
C18			CE04KW1A22M	2200UF		
C19			CE04KW1A101M	100UF		
C20			CF92FV1H104J	0.10UF		
C21 -24			CE04KW1V100M	10UF		
C25			CE04KW1H010M	35KV		
C26			CF92FV1H104J	1.00UF		
C27 , 28			CE04KW1J100M	0.10UF		
X1		*	L78-0290-05	RESONATOR (8MHZ)		
X2			L78-0244-05	RESONATOR (4MHZ)		
D			N89-3008-45	BINDING HEAD TAPTITE SCREW		
E			N35-3008-46	BINDING HEAD MACHIN SCREW		
CP1			R90-0483-05	MULTI-COMP		
CP2			R90-0851-05	MULTI-COMP		
CP3 , 4			R90-0855-05	MULTI-COMP		
CP5 -19			R90-0500-05	MULTI-COMP		
CP20			R90-0850-05	MULTIPLE RESISTOR 100KX3		
R48			RS14KB3A560J	FL-PROOF RS 56		
S1 -25			S40-1064-05	PUSH SWITCH		
D1 -23			HSS104	DIODE		
D1 -23			ISS133	DIODE		
D26			HZ55.1N(B2)	ZENER DIODE		
D26			RD5.1ES(B2)	ZENER DIODE		
D27 , 28			HZ54.7N(B)	ZENER DIODE		
D27 , 28			RD4.7ES(B)	ZENER DIODE		
D29 , 30			HZ56.2N(B2)	ZENER DIODE		
D29 , 30			RD6.2ES(B2)	ZENER DIODE		
D31			HZ53.9N(B2)	ZENER DIODE		
D31			RD3.9ES(B2)	ZENER DIODE		
D33 , 34			HSS104	DIODE		
D33 , 34			ISS133	DIODE		
ED1			FIP21DMW24	FLUORESCENT INDICATOR TUBE		
IC1 , 2		*	XR-1091DCP	IC(GE DISPLAY FILTER)		
IC3			TC74HC4051AP	IC(ANALOG MULTIPLEXER)		
IC4		*	BA10393	IC(DUAL COMPALATOR)		
IC5			M50747-F92SP	IC(MICROPROCESSOR)		

* New Parts
 Parts without Parts No. are not supplied.
 Les articles non mentionnés dans le Parts No. ne sont pas fournis.
 Teile ohne Parts No. werden nicht geliefert.

3

Ref. No. 参照番号	Address 位置	New Parts 新	Parts No. 部品番号	Description 部品名 / 規格	Desti- nation 仕	Re- marks 備考
C94			CE04KW1H470M	47UF		
C95			CE04DW1J101M	50KV		
C96			CE04KW2A471M	100UF		
C97			CE04KW2A471M	4700UF		
C98			CK45FF1H103Z	0.010UF		
C99 , 100			CE04KW1V4R7M	4.7UF		
C101-104			CK45FF1H103Z	0.010UF		
C101, 102			CK45FF1H103Z	0.010UF		
E1			E03-0108-05	AC OUTLET		
E2			E03-0109-05	AC OUTLET		
E3			E08-0312-05	RECTANGULAR RECEPTACLE(SYSTEM)		
E3			E13-0446-05	PHONE JACK (4P) (LINE INPUT)		
F1			F05-2525-05	FUSE (SEMKO) (250V T2.5A)		
CN4 , 5			J13-0075-05	FUSE CLIP		
D			N89-3008-45	BINDING HEAD TAPTITE SCREW		
E			N35-3008-46	BINDING HEAD MACHIN SCREW		
CP1 -4			R90-0491-05	MULTI-COMP		
RS1 -53			RD14NB2E681J	RD 680 J 1/4W		
RS4 , 55			RS14KB3D391J	FL-PROOF RS 390 J 2W		
S1			S31-2131-05	SLIDE SWITCH (Power voltage)		
D1			S5668B	DIODE		
D1 -4			1SR139-100	DIODE		
D5 , 6			HSS104A	DIODE		
D5 , 6			ISS131	DIODE		
D7 -10			S5668B	DIODE		
D7 -10			1SP139-100	DIODE		
D11			HZ56.2N(B2)	ZENER DIODE		
D11			RD6.2ES(B2)	ZENER DIODE		
D12			HSS104A	DIODE		
D12			ISS131	DIODE		
D13 , 14			HZ56.8N(B2)	ZENER DIODE		
D13 , 14			RD6.8ES(B2)	ZENER DIODE		
D15			HZ55.1N(B2)	ZENER DIODE		
D15			RD5.1ES(B2)	ZENER DIODE		
D16 -24			HSS104A	DIODE		
D16 -24			ISS131	DIODE		
IC1 , 2			NJU7305L	IC(ELECTRIC VOLUME)		
IC3 -6			M5229P	IC(7CH GRAPHIC EQUALIZER)		
IC7			NJM4558D	IC(OP AMP X2)		
IC8			UPC7915HF	IC(VOLTAGE REGULATOR/ -15V)		
IC9			UPC7815HF	IC(VOLTAGE REGULATOR/ +15V)		
Q1			2SC2878(B)	TRANSISTOR		
Q3			2SA1309A(G,R)	TRANSISTOR		
Q3			2SA933S(G,R)	TRANSISTOR		
Q4			2SB941	TRANSISTOR		
Q5			2SA1309A(G,R)	TRANSISTOR		
Q5			2SA933S(G,R)	TRANSISTOR		
Q6 , 7			DTA124ES	DIGITAL TRANSISTOR		
Q6 , 7			UN4112	TRANSISTOR		
Q8 , 9			2SC3246	TRANSISTOR		

L:Scandinavia K:USA P:Canada
 Y:PX(Far East, Hawaii) T:England E:Europe
 Y:AFES(Europe) X:Australia M:Other Areas
 Δ indicates safety critical components.

GE-850

PARTS LIST

5

* New Parts
 Parts without Parts No. are not supplied.
 * Les parties non mentionnées dans le Parts No. ne sont pas fournies.
 Teile ohne Parts No. werden nicht geliefert.

Ref. No. 参照番号	Address 位置	New Parts 新	Parts No. 部品番号	Description 部 品 名 / 規 格	Desti- nation 向	Re- marks 備考
IC6		*	M50945-104SP	IC		
IC7 -12			TC74HC77AP	IC(D-TYPE LATCH)		
IC13			TC74HC4028AP	IC		
Q1			2SA1309A(Q,R)	TRANSISTOR		
Q1			2SA933S(Q,R)	TRANSISTOR		
Q2			2SD1266(Q,P)	TRANSISTOR		
Q3			2SC1740S(Q,R)	TRANSISTOR		
Q3			2SC3311A(Q,R)	TRANSISTOR		
Q4 -29			DTA124ES	DIGITAL TRANSISTOR		
Q4 -29			UN4112	TRANSISTOR		
Q30 ,31			DT0124ES	DIGITAL TRANSISTOR		
Q30 ,31			UN4212	TRANSISTOR		
Q32 -70			DTA124ES	DIGITAL TRANSISTOR		
Q32 -70			UN4112	TRANSISTOR		
Q73 -94			DTA124ES	DIGITAL TRANSISTOR		
Q73 -94			UN4112	TRANSISTOR		
Q95			2SC2003(L,K)	TRANSISTOR		

L:Standard
 Y:Y (Japan)
 Y:Y (Taiwan)
 Y:Y (Europe)
 K:USA
 T:England
 X:Australia
 P:Canada
 E:Europe
 M:Other Areas
 A: Indicates special order components

GE-850

SPECIFICATIONS

[Performance]

Equalizer characteristic variable range	±12dB
Center frequencies	40Hz, 63Hz, 98Hz, 160Hz, 250Hz, 400Hz, 625Hz, 1kHz, 1.5kHz, 2.5kHz, 3.9kHz, 6.3kHz, 10kHz, 16kHz
Total harmonic distortion (at 1kHz, flat)	0.006%
Gain	0dB
Frequency response	10Hz to 70kHz, ±3dB
Maximum output voltage (at 1% T.H.D)	9V
Signal to noise ratio (IHF'66)	100dB
Input impedance	47kΩ
Output impedance	2.2kΩ

[General]

Power consumption	19W
AC outlets (except for Australia) UNSWITCHED	1(200W max.)
Dimensions	W : 360mm H : 109mm D : 353mm
Weight (Net)	3.4kg

Note:

KENWOOD follows a policy of continuous advancements in development. For this reason specifications may be changed without notice

Note :

Component and circuitry are subject to modification to insure best operation under differing local conditions. This manual is based on, the Europe (E) standard, and provides information on regional circuit modification through use of alternate schematic diagrams, and information on regional component variations through use of parts list.

KENWOOD CORPORATION

Shionogi Shibuya Building, 17-5, 2-chome Shibuya, Shibuya-ku, Tokyo 150, Japan

KENWOOD U.S.A. CORPORATION

2201 East Dominguez Street, Long Beach, CA 90810;

550 Clark Drive, Mount Olive, NJ 07828, U.S.A.

KENWOOD ELECTRONICS CANADA INC.

P.O. BOX 1075, 959 Gana Court, Mississauga, Ontario, Canada L4T 4C2

TRIO-KENWOOD U.K. LTD.

KENWOOD HOUSE, Dwight Road, Watford, Herts., WD1 8EB United Kingdom

KENWOOD ELECTRONICS BENELUX N.V.

Mechelsesteenweg 418 B-1930 Zaventem, Belgium

KENWOOD ELECTRONICS DEUTSCHLAND GMBH

Rembrücker-Str. 15, 6056 Heusenstamm, Germany

TRIO-KENWOOD FRANCE S.A.

13 Boulevard Ney, 75018 Paris, France

KENWOOD LINEAR S.p.A.

20125, MILANO-VIA ARBE, 50, ITALY

KENWOOD ELECTRONICS AUSTRALIA PTY. LTD. (INCORPORATED IN N.S.W.)

P.O. BOX 504, 8 FIGTREE DRIVE, AUSTRALIA CENTRE, HOMEBUSH, N.S.W. 2140, AUSTRALIA

KENWOOD & LEE ELECTRONICS, LTD.

Wang Kee Building, 4th Floor, 34-37, Connaught Road, Central, Hong Kong